

User Manual

SC51T

PTN Compact Scaler Switcher



All Rights Reserved

Version: SC51T_2015V1.8

SAFETY PRECAUTIONS

To insure the best from the product, please read all instructions carefully before using the device. Save this manual for further reference.

- Unpack the equipment carefully and save the original box and packing material for possible future shipment
- Follow basic safety precautions to reduce the risk of fire, electrical shock and injury to persons.
- Do not dismantle the housing or modify the module. It may result in electrical shock or burn.
- Using supplies or parts not meeting the products' specifications may cause damage, deterioration or malfunction.
- Refer all servicing to qualified service personnel.
- To prevent fire or shock hazard, do not expose the unit to rain, moisture or install this product near water.
- Do not put any heavy items on the extension cable in case of extrusion.
- Do not remove the housing of the device as opening or removing housing may expose you to dangerous voltage or other hazards.
- Install the device in a place with fine ventilation to avoid damage caused by overheat.
- Keep the module away from liquids.
- Spillage into the housing may result in fire, electrical shock, or equipment damage. If an object or liquid falls or spills on to the housing, unplug the module immediately.
- Do not twist or pull by force ends of the optical cable. It can cause malfunction.
- Do not use liquid or aerosol cleaners to clean this unit. Always unplug the power to the device before cleaning.
- Unplug the power cord when left unused for a long period of time.
- Information on disposal for scrapped devices: do not burn or mix with general household waste, please treat them as normal electrical wastes.

NOTICE:

1. Please read this user manual carefully before using this product.
2. The item PoC is short for Power over Cable, and when the power adapter is connecting with TPHD402PR, SC51T can't be energized through PoC.
3. The receiver works with SC51T can only be TPHD402PR.
4. The item "far-end" means the device (e.g. display device, 3rd party RS232 device etc) connected with TPHD402PR.
5. Take notice to 4.6 Instructions of VGA Converting Cable when using.
6. Pictures shown in this manual are for reference only, different model and specifications are subject to real product.

This manual is for operation instruction only, not for any maintenance usage. The functions described in this version are updated till January 2015. Any changes of functions and parameters since then will be informed separately. Please refer to the dealers for the latest details.

This manual is copyright PTN Electronics Limited. All rights reserved. No part of this publication may be copied or reproduced without the prior written consent of PTN Electronics Limited.

All product function is valid till 2015-01-12.

Contents

1. Introduction.....	1
1.1 Introduction to SC51T.....	1
1.2 Features.....	1
1.3 Package List.....	1
2. Product Appearance.....	2
2.1 SC51T Front Panel.....	2
2.2 SC51T Rear Panel.....	4
3. System Connection.....	5
3.1 Usage Precautions.....	5
3.2 System Diagram.....	5
3.3 Connection Procedure.....	6
3.4 Connection of Microphone.....	6
3.5 Application.....	8
4. System Operations.....	8
4.1 Operations of Front Panel Buttons.....	8
4.1.1 Resolution Adjusting.....	8
4.1.2 Switching Operations.....	9
4.1.3 Volume Adjusting.....	10
4.1.4 Used in OSD Menu.....	10
4.1.5 Software updating:.....	10
4.2 Operations of IR.....	11
4.2.1 IR Remote.....	11
4.2.2 IR Operations.....	12
4.3 Operations of CEC Function.....	13
4.4 Operations of RS232 Control.....	14
4.4.1 Installation/uninstallation of RS232 Control Software.....	14
4.4.2 Basic Settings.....	14
4.4.3 RS232 Communication Commands.....	16
4.4.4 Control SC51T or 3rd Party Device from Local.....	23
4.4.5 Control SC51T from Local or Remote.....	24
4.5 Operations in OSD Menu.....	25

4.5.1 Option.....	25
4.5.2 Picture.....	27
4.5.3 Sound.....	27
4.5.4 Setup.....	28
4.6 Instructions of VGA Converting Cable.....	29
5. Specification.....	30
6. Panel Drawing.....	32
7. Troubleshooting & Maintenance.....	32
8. After-sales Service.....	34

1. Introduction

1.1 Introduction to SC51T

SC51T is a compact mini scaler switcher with 5 video inputs (3 HDMI, 2 VGA) and 6 audio inputs (3 HDMI audio & 2 VGA audio: switched following the video; 1 MIC audio input). As the VGA input supports VGA, YPbPr and C-video, so the scaler switcher is compliant with multiple video signals.

SC51T scales & switches any video signal to HDMI output and HDBaseT output (supports PoC, connects with TPHD402PR, max transmission distance is 60 meters).

And with 1 IR IN, 5 IR OUT & 1 RS232, IR & RS232 signal can be transmitted bi-directionally between SC51T and TPHD402PR.

1.2 Features

- Compliant with HDCP
- Supports CEC, with commands to enable/disable this function
- Supports video source auto-switching function
- Bi-directional IR & RS232 control
- Output resolutions selectable to assure preferred output, and supports various output resolutions, such as 1920x1200, 1920x1080, 1600x1200, 1360x768, 1280x800, 1280x720, 1024x768
- VGA video supports C-video, YPbPr and VGA
- Supports online software upgrading
- 48V phantom power to support condenser microphone
- MIC port supports balance/unbalance signal, suppress the external noise effectively
- 3-level MIC input, supports condenser microphone, dynamic microphone and wireless microphone
- Controllable via button, IR & RS232
- Powerful OSD function

1.3 Package List

- 1 x SC51T
- 2 x Mounting ears (for SC51T)
- 1 x TPHD402PR
- 2 x Mounting ears (for TPHD402PR)
- 5 x Screws (black color)
- 7 x Captive screw connectors
- 1 x IR receiver (with carrier wave)

Compact Scaler Switcher (with PoC)

- 1 x IR emitter
- 2 x VGA to YPbPr cables
- 2 x RS232 cable
- 8 x Plastic cushions
- 1 x IR remote (Cell battery is not included)
- 1 x Power Adapter (DC 12V)
- 1 x User Manual

Notes: Please confirm if the product and the accessories are all included, if not, please contact with the dealers.

2. Product Appearance

2.1 SC51T Front Panel

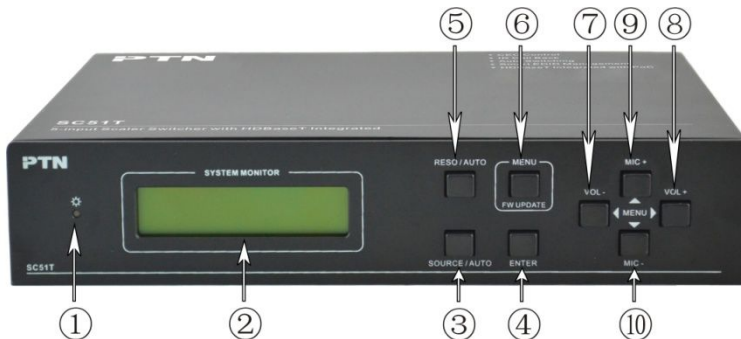

- ① Power indicator
Illuminate red when power on, turn green in standby mode.
- ② LCD screen
Show real-time system working status
- ③ SOURCE/AUTO
 - Used as video source selection button, press to select one source, press again to select next source, switching circularly between HDMI1, HDMI2, HDMI3, VGA1 and VGA2. The LCD screen will show the name of selected source.
 - Used as switching mode selection button, press and hold for **7 seconds or more** to enter in Auto-switching mode, press and hold for **7 seconds or more** again to enter in Manual-switching mode.

Note: Setting any VGA port to AV or YPbPr in Manual-switching mode, the system will not be able to enter in Auto-switching mode. While in Auto-switching mode, setting any VGA port to AV or YPbPr will automatically enter in Manual-switching mode, and the

Compact Scaler Switcher (with PoC)

LCD screen and RS232 control software will prompt "Not support!".

- ④ ENTER
 - Confirm selection in menu.
- ⑤ RESO/AUTO
 - Used as output resolution manual switching button, select among 1920x1200, 1920x1080, 1600x1200, 1360x768, 1280x800, 1280x720, 1024x768.
 - Used as output resolution switching mode selection button, press and hold for **7 seconds or more** to enter in Auto-switching mode, press and hold for **7 seconds or more** again to enter in Manual-switching mode.
- ⑥ MENU/FWUPDATE
 - Used as menu button, press it to enter in OSD menu.
 - Used as software updating button, press and hold for **7 seconds or more** to enter in software updating procedure.
- ⑦ VOL-
 - Used as volume down button.
 - Used as direction button NEXT in menus.
- ⑧ MIC+
 - Used as MIC volume up button.
 - Used as direction button MOVE UP in menus.
- ⑨ VOL+
 - Used as volume up button.
 - Used as direction button PREVIOUS in menus.
- ⑩ MIC-
 - Used as MIC volume down button.
 - Used as direction button MOVE DOWN in menus.

Note: Pictures shown in this manual are for reference only, different model and specifications are subject to real product.

2.2 SC51T Rear Panel

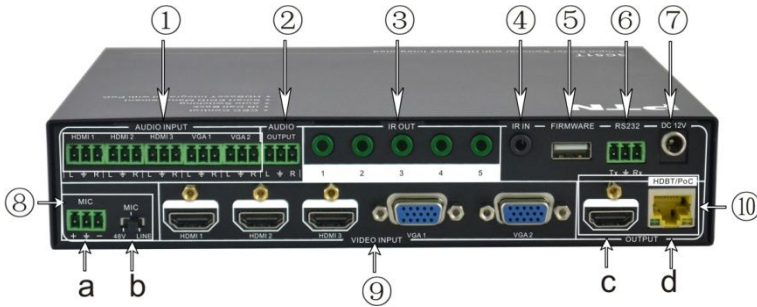

- ① **AUDIO INPUT**
Including 3 HDMI audio & 2 VGA audio inputs
User can choose any one audio (embedded HDMI audio or external input audio) for HDMI audio input by sending RS232 commands.
- ② **AUDIO OUTPUT**
Audio output port, the audio comes from the input audio corresponding to the selected video source and mixed with MIC audio.
- ③ **IR OUT**
5 in total, connect with IR emitters to control local source devices or SC51T from remote, switched along with corresponding video source.
- ④ **IR IN**
Connects with IR receiver (with carrier wave only), to receive IR signal send by the IR remote or remote controller of other input/output device.
- ⑤ **FIRMWARE**
USB port, connects with USB flash disk or other storage which is with update file inside, to update the system firmware.
- ⑥ **RS232**
Serial control port, 3-pin captive screw connector, connect with a control device (such as a computer) to control SC51T or other devices connected with TPHD402PR.
- ⑦ **DC 12V**
Power port, connect with DC 12V power adapter.
- ⑧ **MIC**
 - a) **MIC port**
Connect with microphone
 - b) **Dial switch**

Compact Scaler Switcher (with PoC)

Including 3 levels: 48V phantom power mode (connect with condenser microphone), MIC mode (connect with dynamic microphone) and LINE mode (connect with wireless microphone or line audio).

⑨ VIDEO INPUT

Video input ports, include 3 HDMI inputs & 2 VGA inputs.

VGA ports support YPbPr, C-video and VGA format. Factory default is VGA format.

⑩ OUTPUT

c) HDMI local output

d) HDBaseT output, support PoC.

The two ports share the same audio signal, and the audio signal is mixed with MIC audio and HDMI embedded audio (output audio). If disabling HDMI embedded audio output, there will be no audio output through these ports.

Note: Pictures shown in this manual are for reference only, different model and specifications are subject to real product.

3. System Connection

3.1 Usage Precautions

- 1) System should be installed in a clean environment and has a prop temperature and humidity.
- 2) All of the power switches, plugs, sockets and power cords should be insulated and safe.
- 3) All devices should be connected before power on.

3.2 System Diagram

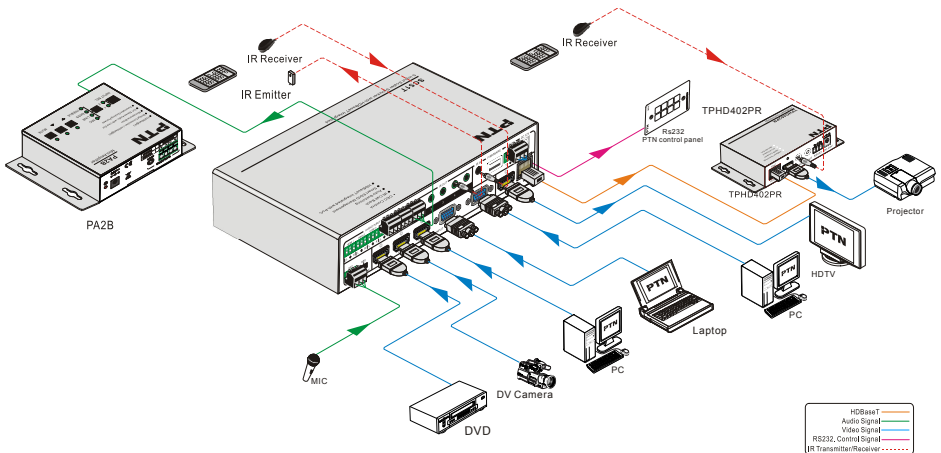

3.3 Connection Procedure

Step1. Connect HDMI source devices (e.g. Blue-ray DVD) to HDMI input ports of SC51T with HDMI cable. Connect VGA source devices (e.g. PC) to VGA input ports of SC51T with VGA cable.

Step2. Connect audio sources to corresponding AUDIO INPUT ports on SC51T with audio cable. The audio of HDMI can be embedded or external by sending the right command.

Step3. Connect a HDMI display device to HDMI output port of SC51T with HDMI cable.

Step4. Connect TPHD402PR to HDBaseT output port of SC51T with twisted pair.

Step5. Connect speaker, headphone or PTN amplifier to AUDIO OUTPUT port of SC51T.

Step6. Connect control device (e.g. PC) to RS232 port of SC51T or TPHD402PR (bi-directional RS232 control, either end is available).

Step7. Both SC51T and TPHD402PR have IR IN and OUT. When one model is connected with IR receiver, the other model should connect with an IR transmitter.

For example: When “IR IN” of SC51T connects with an IR receiver, the IR transmitter must connect to IR OUT of TPHD402PR.

The IR signal can be transmitted bi-directionally between SC51T and TPHD402PR.

Step8. Select MIC level and connect right microphone to MIC input port. MIC audio will be transmitted to AUDIO OUTPUT port and mixed with source audio.

Step9. Connect DC12V power adaptor to the power port (TPHD402PR is able to get power from SC51T with PoC function).

Note: SC51T supports unidirectional PoC, i.e., If the power adapter is connecting with SC51T, TPHD402PR can get power from SC51T; but when the power adapter is connecting with TPHD402PR, SC51T can get power from TPHD402PR.

3.4 Connection of Microphone

SC51T provides with one 3-level microphone input port, to accommodate different microphone input modes, including 48V phantom power mode, MIC mode & LINE mode.

➤ 48V phantom power input

48V phantom power input has a good frequency characteristic, high input impedance and high sensitivity.

When switching to “48V”, the MIC input will provide a 48V phantom power. This is only used for **condenser microphone**.

Connect the microphone in this way: “+” connects to positive, “-” connects to negative

Compact Scaler Switcher (with PoC)

and “ \equiv ” to ground.

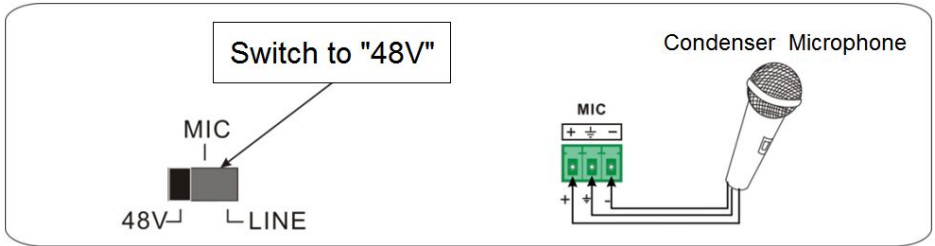

➤ MIC input

MIC input has a low frequency characteristics, and wide frequency response.

When switch to “MIC”, the microphone input is used for connecting with **dynamic microphone**. There are two different connection methods:

1) Unbalanced connection:

“+” and “ \equiv ” connect to ground, and “-” connects to signal.

“-” and “ \equiv ” connect to ground, and “+” connects to signal.

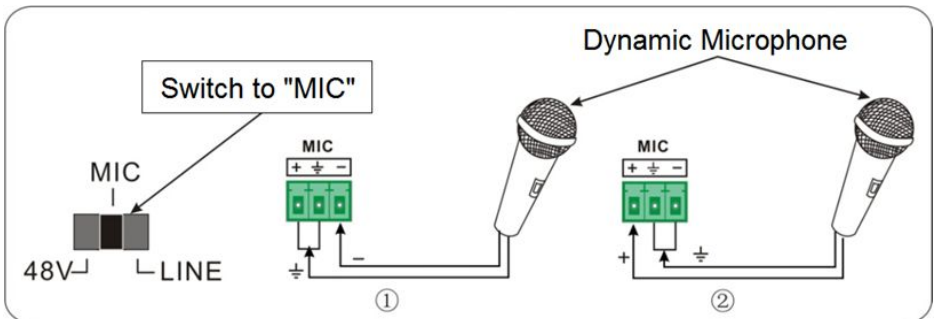

2) Balanced connection: “+” connects to positive, “-” connects to negative and “ \equiv ” connects to ground.

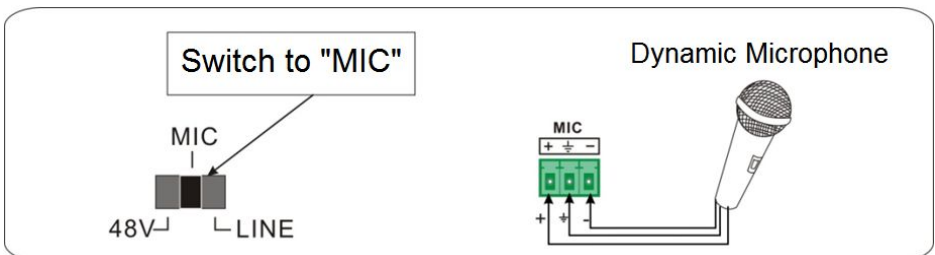

➤ LINE input

LINE input has a low frequency characteristics, and wide frequency response.

Compact Scaler Switcher (with PoC)

When switch to “LINE”, the microphone input is used for connecting with line audio or wireless microphone output. There are two different connection methods:

1) Unbalanced connection:

“+” and “ \perp ” connect to ground, and “-” connects to signal.

“-” and “ \perp ” connect to ground, and “+” connects to signal.

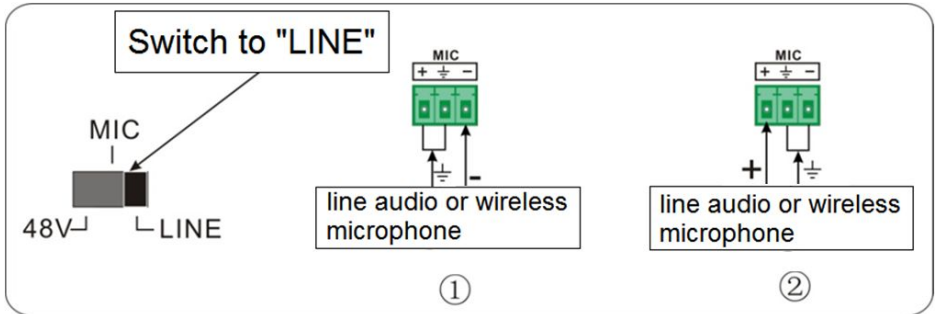

2) Balanced connection: “+” connects to positive, “-” connects to negative and “ \perp ” connects to ground.

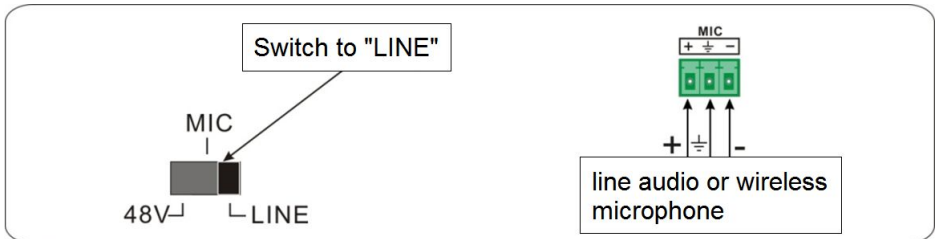

3.5 Application

SC51T has a good application in various occasions, such as computer realm, monitoring, conference room, big screen displaying, television education, command & control center and smart home etc.

4. System Operations

4.1 Operations of Front Panel Buttons

Front panel buttons can be used for output resolution adjusting, switching operations, software updating, volume adjusting and other operations in menus.

4.1.1 Resolution Adjusting

Resolution supports auto-adjusting and manual-adjusting. Press and hold for **RESO/AUTO** button for **7 seconds or more** to switch between auto-adjusting/manual-adjusting mode.

Note:

Compact Scaler Switcher (with PoC)

1. In auto-adjusting mode, SC51T will choose the resolution of the display device at the far-end as the preferred resolution.

If you need to choose the resolution of local HDMI display device:

- ☆ Cut off the power of SC51T and disconnect SC51T and TPHD402PR.
- ☆ Turn on the power of SC51T.
- ☆ Gets the resolution of local HDMI output device.
- ☆ Connect TPHD402PR to SC51T.

2. In auto-switching mode, front panel button control is not available, but IR and RS232 control are able to switch modes.

4.1.2 Switching Operations

Video signals support auto-switching and manual-switching. Press and hold for **SOURCE/AUTO** button for **7 seconds or more** to enter in auto-switching/manual-switching mode.

The display result is showed as below:



IN: HDMI1 MANUAL
1280 X 720



IN: HDMI1 AUTO
1280 X 720

The display result will be showed for **2 seconds**.

Auto-switching function

The auto-switching mode abides by the following principles:

- **New input principle**
Once detecting a new input signal, SC51T would switch to this new signal automatically.
- **Power rebooting principle**
SC51T offers the function to remember the last displayed signal when rebooting. Once rebooted, SC51T will automatically enter auto-switching mode, and then detect all inputs and memorize their connection status for future rebooting using.
If the last displayed signal is still available, SC51T will output the signal. If not, there will be no signal on output devices.
- **Signal removing principle**
Once removing the current display signal, SC51T will detect all input signals with priority from INPUT 1 to INPUT 5. It will transfer the signal firstly detected to be available to output devices.

Notice: Auto-switching function works only when inputting new signal, removing a signal or power rebooting. With any VGA port set to AV or YPbPr, the system will be not able to

Compact Scaler Switcher (with PoC)

enter in Auto-switching mode.

Operation Examples:

- Connect INPUT 2, INPUT 4, and INPUT 5 ports with source devices, select INPUT 4 to outputs.
- Press and hold for the front key **SOURCE/AUTO** for **7 seconds or more** to enter in auto-switching mode.
- No signal removing or new input, SC51T just works in auto-switching mode, and take no action (Output from INPUT 4)
- Connect INPUT 3 with a source device, and then it will choose INPUT 3 to output.
- Remove the signal of INPUT 3, SC51T will detect from INPUT 1 to INPUT 5. And when it detects that input 2 is available, it will choose INPUT 2 to output.
- Cut off the power of SC51T, then reboot. As SC51T is in auto-switching mode, it will choose INPUT 2 to output.

4.1.3 Volume Adjusting

Not in OSD menu, press VOL – to decrease line volume, VOL + to increase.

Not in OSD menu, press MIC – to decrease MIC volume, MIC + to increase.

4.1.4 Used in OSD Menu

Press **MENU** button to enter in OSD menu, and use **UP**, **DWON**, **LEFT**, **RIGHT** button to navigate, press **ENTER** button to confirm selection. **MENU** button also can be used to exit present menu level by level until exit the OSD menu.

4.1.5 Software updating:

SC51T supports software updating via USB flash disk.

Procedures:

- 1) Copy the file "**MERGE_51T.bin**" to the root directory of a USB flash disk. (Make sure the file is copied to the root directory for normal use. The "**MERGE_51T.bin**" file is provided/ authorized by PTN engineering department or from our website: <http://www.PTN-electronics.com>)
- 2) Plug the USB flash disk to the SC51T USB port on its front panel.
- 3) Press the button "MENU" for **7 seconds or more** to update the software automatically.

Or press this button for **1 second** to open the OSD menu "Option" → Select "Software Update" to enter in update procedure.

Or send command **50689%** to update software.

4.2 Operations of IR

4.2.1 IR Remote

As IR signal can be transmitted bi-directionally between SC51T and TPHD402PR, it is able to use the IR remote at the far-end to control SC51T or HDMI source devices (via CEC function buttons).

The diagram shows a black IR remote control with various buttons grouped into sections. Callouts 1 through 6 and area 'a' point to specific buttons:

- 1 Standby button**: Enter/ exit standby mode
- 2 Input channel selection buttons**: INPUT 1 is for HDMI1, INPUT 2 for HDMI2...INPUT 5 for VGA2. **AUTO**: Enable/disable auto-switching mode.
- 3 Volume adjusting buttons**:
 - MIC-/+: turn down/ up MIC volume
 - LINE-/+: turn down/ up line volume
 - MIC MUTE: mute/ unmute MIC audio
 - LINE MUTE: mute/ unmute line audio
- 4 Menu operation buttons**:
 - MENU**: press to enter in OSD menu or used to return to previous menu; **EXIT**: exit OSD menu.
 - OK**: confirm button; **Navigation buttons**: UP/DWON/LEFT/ RIGHT button, for value setting or page-turn, Buttons in area **a** are also able to work in CEC mode to enter the menu of HDMI source device; **P.P, ZOOM, S.M**: shortcut button, to select display mode.
- 5 Resolution selection buttons**: Select resolution by pressing corresponding button. **AUTO**: Enable/disable auto-switching mode.
- 6 CEC function buttons**: (For HDMI input signal which supports CEC only) Including PLAY, PAUSE, STOP, MENU, REV (reverse) and FWD (forward). Buttons in section **a** also work when entered CEC. too.

Compact Scaler Switcher (with PoC)

4.2.2 IR Operations

The 5 IR OUT ports correspond to the 5 video inputs separately, and the IR signals are switched following the corresponding video source.

1) Control far-end device from local

Control SC51T or far-end display device from local through corresponding IR remote.

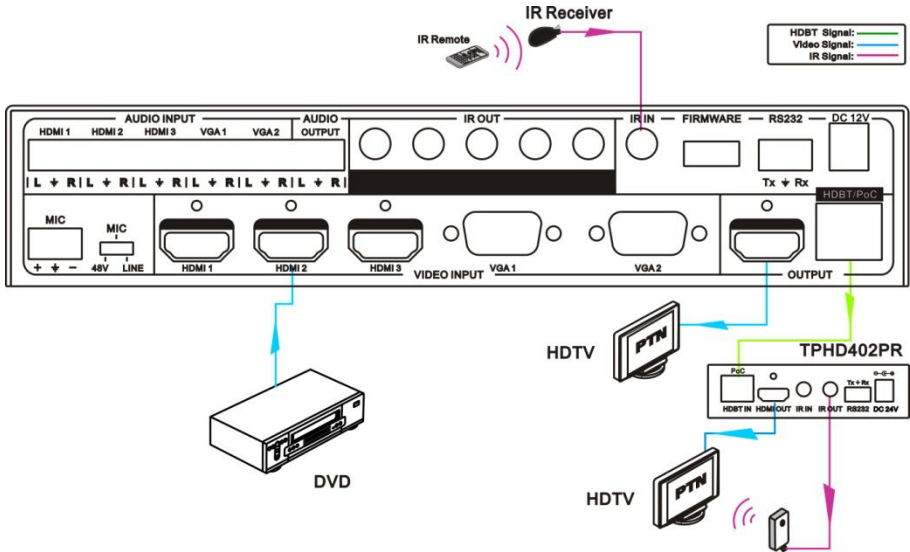

2) Control local device from remote

Control SC51T or local device from local through corresponding IR remote.

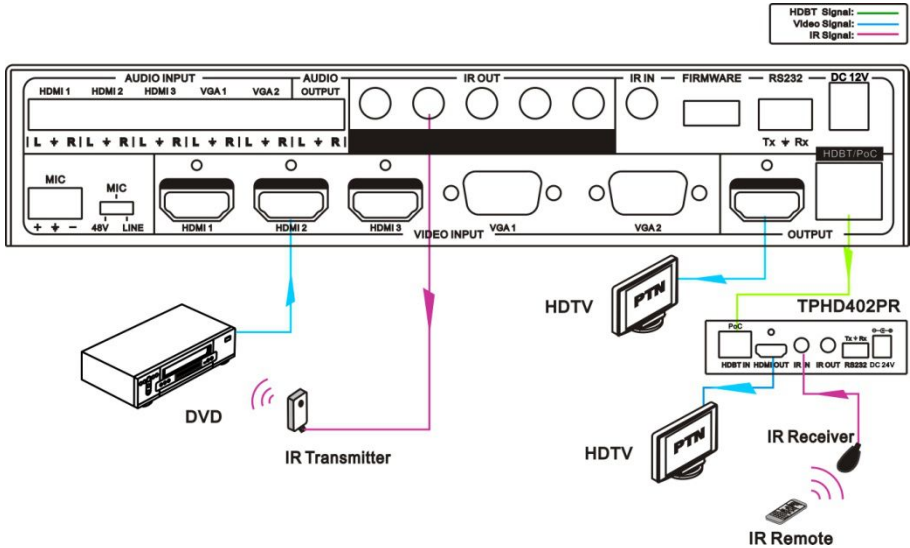

4.3 Operations of CEC Function

SC51T supports CEC, it can be turned on/ off by sending RS232 commands or OSD menu operations. The default setting is ON.

Commands pertaining to CEC: “50686%” (enable CEC) and “50687%” (disable CEC)

HDMI INPUT ports 1~3 support CEC, if the connected source devices also support CEC and their CEC are on, users can control the source device via the IR remote of SC51T.

The working status related to CEC and STANDBY is showed as below:

Situation	Working Status
CEC: on, Standby: on	Press STANDBY button on IR remote, SC51T enters in standby mode, so do all HDMI source devices. Press STANDBY button again on IR remote, SC51T exits standby mode, the HDMI source devices start working too.
CEC: on, Standby: off	Press STANDBY button on IR remote, SC51T enters in standby mode, HDMI 1~3 source devices keep on.
CEC: on	Use CEC function buttons, ▲, ▼, ◀, ▶ and OK buttons on IR remote to control HDMI source devices, include play, pause, fast forward, fast reverse and operations in menu.
CEC: off	Unable to control HDMI source devices through IR remote

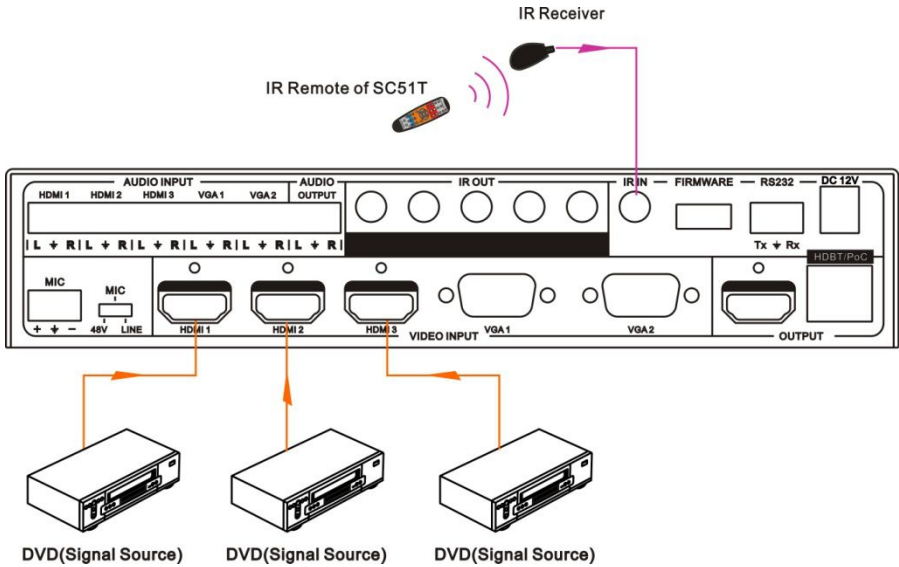

CEC: Control HDMI source devices by IR remote of SC51T

4.4 Operations of RS232 Control

As RS232 can be transmitted bi-directionally between SC51T and TPHD402PR, so it is able to control a third party RS232 device from local or control SC51T from remote. When to control a third party RS232 device, the baud rate of this device should be 2400, 4800, 9600, 19200, 38400, 57600 or 115200.

4.4.1 Installation/uninstallation of RS232 Control Software

- **Installation** Copy the control software file to the computer connected with SC51T.
- **Uninstallation** Delete all the control software files in corresponding file path.

4.4.2 Basic Settings

First to connect SC51T with all input devices and output devices needed, then to connect it with a computer which is installed with RS232 control software. Double-click the software icon to run this software.

Here we take the software **CommWatch.exe** as example. The icon is showed as below:



The interface of the control software is showed as below:

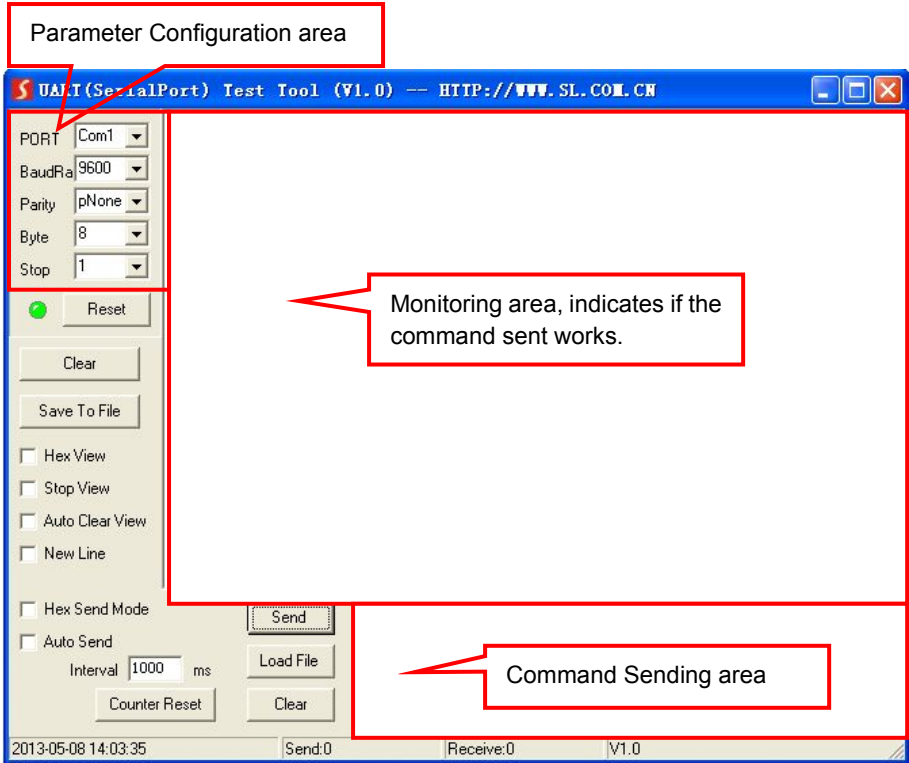

Please set the parameters of COM number, bound rate, data bit, stop bit and the parity bit correctly, and then you are able to send command in Command Sending Area.

Compact Scaler Switcher (with PoC)

4.4.3 RS232 Communication Commands

Communication protocol: RS232 Communication Protocol

Baud rate: 9600

Data bit: 8

Stop bit: 1

Parity bit: none

Command	Function	Feedback Example
Switch Commands		
50701%	Switch to HDMI 1 input	Switch to HDMI 1
50702%	Switch to HDMI 2 input	Switch to HDMI 2
50703%	Switch to HDMI 3 input	Switch to HDMI 3
50704%	Switch to VGA 1/YPbPr 1/AV 1 input	Switch to VGA 1/YPbPr 1/AV 1
50705%	Switch to VGA 2/YPbPr 2/AV 2 input	Switch to VGA 2/YPbPr 2/AV 2
50680%	Select VGA 1 for INPUT 4	Input 4 Set & Switch to VGA 1
50681%	Select YPbPr 1 for INPUT 4	Input 4 Set & Switch to AV 1
50682%	Select AV 1 for INPUT 4	Input 4 Set & Switch to AV 1
50683%	Select VGA 2 for INPUT 5	Input 5 Set & Switch to VGA 2
50684%	Select YPbPr 2 for INPUT 5	Input 5 Set & Switch to YPbPr 2
50685%	Select AV 2 for INPUT 5	Input 5 Set & Switch to AV 2
50785%	Enable auto-switching	Auto Switching
50786%	Disable auto-switching	Manual Switching
Audio Commands		
50600%	MUTE line audio	LINE Mute
50601%	UnMute line audio	LINE Unmute
50602%	Line audio volume up	LINE Volume: xx (xx=00~60)
50603%	Line audio volume down	LINE Volume: xx (xx=00~60)
50720%	Mute LINE audio & MIC audio	LINE Mute
		MIC Mute
50721%	Unmute LINE audio & MIC audio	LINE Unmute
		MIC Unmute
50722%	Mute MIC audio	MIC Mute
50723%	Unmute MIC audio	MIC Unmute
50694%	Enable Mic precedence	Mic precedence: enable
50695%	Disable Mic precedence	Mic precedence: disable

Command	Function	Feedback Example
50696%	Check Mic precedence status	Mic precedence: XXXX (XXXX=enable / disable)
50724%	MIC volume up	MIC Volume: xx (xx=00~60)
50725%	MIC volume down	MIC Volume: xx (xx=00~60)
508xx%	Set MIC volume	MIC Volume: xx (xx=00~60)
50706%	Choose embedded audio as HDMI 1 audio input	HDMI 1 Audio from Embedded
50707%	Choose external audio as HDMI 1 audio input	HDMI 1 Audio from LINE
50708%	Choose embedded audio as HDMI 2 audio input	HDMI 2 Audio from Embedded
50709%	Choose external audio as HDMI 2 audio input	HDMI 2 Audio from LINE
50710%	Choose embedded audio as HDMI 3 audio input	HDMI 3 Audio from Embedded
50711%	Choose external audio as HDMI 3 audio input	HDMI 3 Audio from LINE
Resolution Commands		
50619%	Change the resolution to 1360X768 HD	Resolution: 1360x768
50626%	Change the resolution to 1024X768 XGA	Resolution: 1024x768
50627%	Change the resolution to 1280X720 720P	Resolution: 1280x720
50628%	Change the resolution to 1280X800 WXGA	Resolution: 1280x800
50629%	Change the resolution to 1920X1080 1080P	Resolution: 1920x1080
50620%	Change the resolution to 1920X1200 WUXGA	Resolution: 1920x1200

Command	Function	Feedback Example
50621%	Change the resolution to 1600X1200 UXGA	Resolution: 1600x1200
Setup Commands		
50604%	Lock the front panel buttons	Front Panel lock
50605%	Unlock the front panel buttons	Front Panel Unlock
501xx%	Set the volume to xx.	LINE Volume: xx (xx=00~60)
502xx%	Set the brightness to xx.	Brightness: xx (xx=00~99)
503xx%	Set the contrast to xx.	Contrast: xx (xx=00~99)
504xx%	Set the saturation to xx.	Saturation: xx (xx=00~99)
505xx%	Set the sharpness to xx.	Sharpness: xx (xx=00~99)
50607%	Adjust the color temperature	Color Temperature: xx (xx= Cool/ Medium/ Warm/ User.)
50608%	Set the aspect ratio	Aspect Ratio: xx (xx= 16:9/ 4:3/ auto/ panorama/ justscan/ zoom1/ zoom2, when the input source is VGA format, xx can only be 4:3, 16:9 or Panorama)
50614%	Set the picture mode	Picture Mode: xx (xx= dynamic/ standard/ mild/ user)
50615%	Set SM audio mode	Sound Mode: xx (xx= standard/ music/ movie/ sports/ user)
50655%	Freeze output image	Freeze: enable
50656%	Cancel the freezing of output image	Freeze: disable
50646%	Enable MIC Volume Icon display	Volume Icon: enable
50647%	Disable MIC Volume Icon display	Volume Icon: disable
50648%	Enable HDMI embedded audio output	Embedded Audio Output: enable
50649%	Disable HDMI embedded audio output	Embedded Audio Output: disable

Command	Function	Feedback Example
50761%	Not display mute icon of LINE audio	LINE Mute Icon: disable
50762%	Display mute icon of LINE audio	LINE Mute Icon: enable
50763%	Not display mute icon of MIC audio	MIC Mute Icon: disable
50764%	Display mute icon of MIC audio	MIC Mute Icon: enable
50765%	Display freeze icon	Freeze Icon: enable
50766%	Not display freeze icon	Freeze Icon: disable
50644%	Display channel status	Input Icon: enable
50645%	Not display channel status	Input Icon: disable
50650%	Check the channel status	Input Icon: xx
50606%	Auto-adjust the input parameter(VGA only)	VGA Input Auto
50699%	Check the system version	Version Vx.x.x
50688%	Enable MIC noise detecting	MIC detect: enable
50689%	Disable MIC noise detecting	MIC detect: disable
50690%	Check MIC noise detecting status	MIC detect: XXXX
50791%	HDCP Active	HDCP Active
50792%	HDCP Manual	HDCP Manual
50793%	Enable HDCP output	HDCP ON
50794%	Disable HDCP output	HDCP OFF
50795%	Inquire HDCP/ Active HDCP	HDCP Active
	Inquire HDCP/ Manual HDCP	HDCP Manual
		HDCP OFF/ON
50767%	Restore default EDID	EDID: initial
50768%	Bypass EDID data from output to input	EDID: bypass
50769%	Upload custom EDID data to the switcher	EDID: user
50770%	Inquire EDID status	EDID: initial EDID: bypass EDID: user

Command	Function	Feedback Example
50782%	EDID management, copy the best resolution data of one output to HDMI input	EDID manage
		Resolution:1920x1080
50787%	Enable serial control mode 1: control Scaler & far-end from local RS232	RS232 Mode 1: RS232 Control Scaler & Remote
50788%	Enable serial control mode 2: control Scaler from local RS232 and far-end)	RS232 Mode 2: RS232 & Remote Control Scaler
50697%	Exit standby mode	Wake up!
50797%	Enter standby mode	Go to standby!
50698%	Software update	
50617%	Reset to factory defaults	Factory Reset
Menu Commands		
50609%	OK for OSD selection	Key: ok
50610%	LEFT button	Key: left
50611%	RIGHT button	Key: right
50612%	UP button	Key: up
50613%	DOWN button	Key: down
50616%	MENU button (enter OSD)	OSD: Enter
50618%	EXIT button (exit OSD)	OSD: Exit
Inquire Commands		
50630%	Check the volume level	LINE Volume: xx (xx=00~66)
		MIC Volume: xx (xx=00~66)
50631%	Check the input source	Input: xx (xx= HDMI1/ HDMI2/ HDMI3/ VGA1/ VGA2/ YPbPr1/ YPbPr2/ AV1/ AV2)
50632%	Check the output resolution	Resolution: xx (xx=1920×1200/ 1920×1080/ 1600×1200/ 1360×768/ 1280×800/ 1280×720/ 1024×768)
50633%	Check the image mode	Picture Mode: xx (xx= Dynamic/

Command	Function	Feedback Example
		Standard/ Mild/ User)
50634%	Check the audio mode	Sound Mode: xx (xx= Standard/ Music/ Movie/ Sports/ User)
50635%	Check the image aspect ratio	Aspect Ratio: xx (xx= 16:9/ 4:3/ auto/ panorama/ justscan/ zoom1/ zoom2, when the input source is VGA format, xx can only be 4:3, 16:9 or Panorama)
50636%	Check the brightness	Brightness: xx (xx=00~99)
50637%	Check the contrast	Contrast: xx (xx=00~99)
50638%	Check the saturation	Saturation: xx (xx=00~99)
50639%	Check sharpness	Sharpness: xx (xx=00~99)
50640%	Check the color temperature	Color Temperature: xx (xx= Cool/ Medium/ Warm/ User.)
50651%	Check Volume Icon display status	Volume Icon: xxxx
50652%	Check Digital audio output status	Embedded Audio Output: enable/disable
50712%	Check the audio input sources for HDMI 1, 2, 3	HDMI1 Audio from XXXX port
		HDMI2 Audio from XXXX port
		HDMI3 Audio from XXXX port
50751%	Check whether the LINE audio is mute or not	LINE Mute/Unmute
50752%	Check whether the MIC audio is mute or not	MIC Mute/Unmute
50753%	Check the freeze status	Freeze: enable/disable
50754%	Check the panel locked status	Front Panel Lock/UnLock
50783%	Display status including MIC, LINE audio, Resolution, Output Audio on/off, Manual/ Auto-switching modes	Line Volume:XX
		Mic Volume:XX
		Input:XXXX

Command	Function	Feedback Example
		Resolution:XXXX
		Digital Sound Ouput: XXXX
		Switch status: XXXX
Adjustment Commands		
50678%	Enable screen output adjusting	Enter Output Position Adjust
50679%	Disable screen output adjusting	Exit Output Position Adjust
50670%	Move the image to left	Output Position Adjust X xx
50671%	Move the image to right	Output Position Adjust X xx
50672%	Move the image up	Output Position Adjust Y XX
50673%	Move the image down	Output Position Adjust Y xx
50674%	Stretch left from left side (increase image width)	Output Width Adjust xx
50675%	Pull right from left side (decrease image width)	Output Width Adjust xx
50676%	Stretch upwards from bottom side (decrease image height)	Output Height Adjust xx
50677%	Stretch downwards from bottom side (increase image height)	Output Height Adjust xx
50730%	Turn off HDMI output	HDMI power off
50731%	Turn on HDMI output	HDMI power on
50732%	Turn off HDBT output	HDBT power off
50733%	Turn on HDBT output	HDBT power on
50734%	Turn on HDMI& HDBT output synchronously	HDMI HDBT power on
CEC Commands		
50687%	Disable CEC	HDMI CEC OFF
50686%	Enable CEC	HDMI CEC ON
50901%	Play&pause	CEC cmd: play&pause

Command	Function	Feedback Example
50902%	Stop	CEC cmd: stop
50903%	Menu	CEC cmd: menu
50904%	Retreat	CEC cmd: rev
50905%	Forward	CEC cmd: fwd
50906%	Up	CEC cmd: up
50907%	Down	CEC cmd: down
50908%	Left	CEC cmd: left
50909%	Right	CEC cmd: right
50910%	Confirm command	CEC cmd: select
50911%	Exit command	CEC cmd: exit

Note:

- Turn on/ off HDCP auto-management by sending serial commands.
 - When HDCP is set to active, whether output source is with HDCP depends on input source. If the input source is with HDCP, so is the output and vice versa.
- When HDCP is set to Manual, whether the output is with HDCP depends on the statue of HDCP. Turn off HDCP, then the output is without HDCP and vice versa.
- Screen output adjusting avails only when the screen output adjusting is on. Send command 50678% to turn on.
- CEC commands with grey background avails only when CEC is on.
- MIC precedence: In Mute mode, if the MIC noise detecting is on, the device will unmute MIC automatically given the outer noise exceeds the limit of noise detecting. Send 50696% to enable MIC precedence, then the device will not be able to change the mute mode no matter how loud the noise is.

4.4.4 Control SC51T or 3rd Party Device from Local

Firstly, connect the RS232 port of SC51T to RS232 port of PC.

Secondly, send command **50787%** (serial control mode 1, factory default) via RS232 communication software.

Lastly, send the right command of SC51T or other remote RS232 device connected in present system. Connect as below:

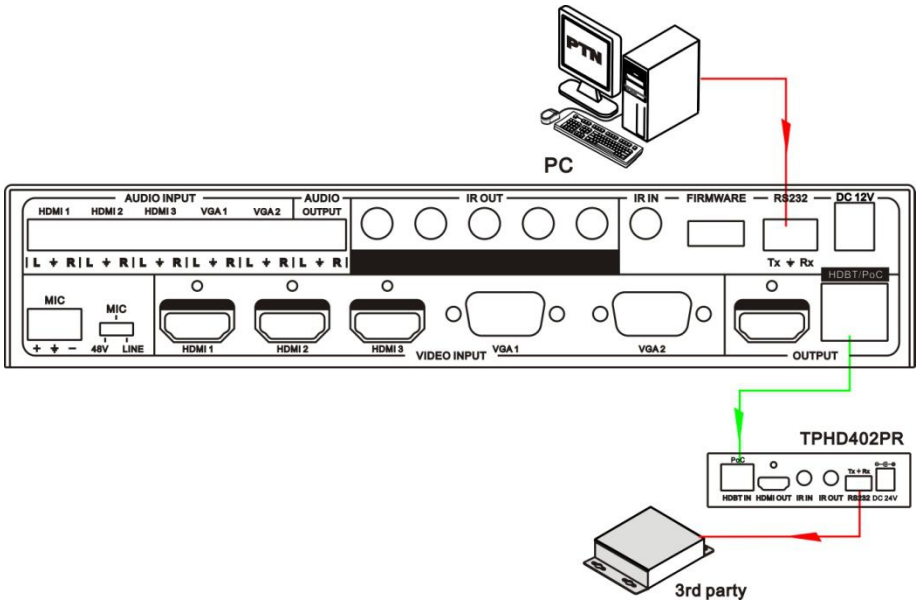

Control SC51T or 3rd party device from local

4.4.5 Control SC51T from Local or Remote

- **Control SC51T from local**

Firstly, connect the RS232 port of SC51T to RS232 port of PC.

Secondly, send command **50788%** via RS232 communication software.

Lastly, send the right command to control SC51T. Connect as below:

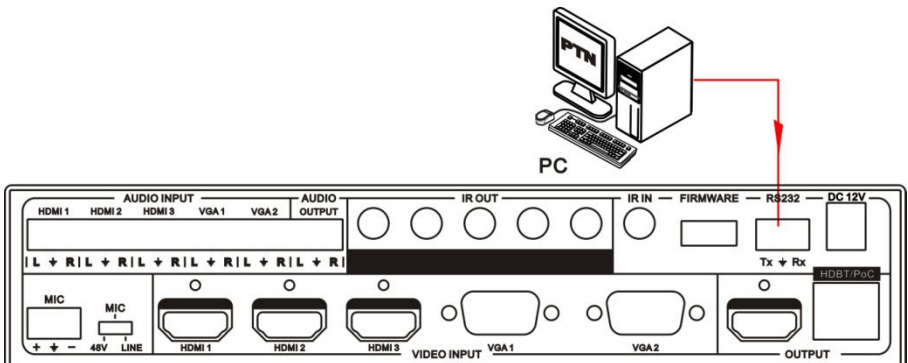

Control SC51T from local

- **Control SC51T from remote**

Compact Scaler Switcher (with PoC)

Firstly, connect the RS232 port of far-end RS232 device to RS232 port of PC.
 Secondly, send command **50788%** via RS232 communication software.
 Lastly, send the right command to control SC51T. Connect as below:

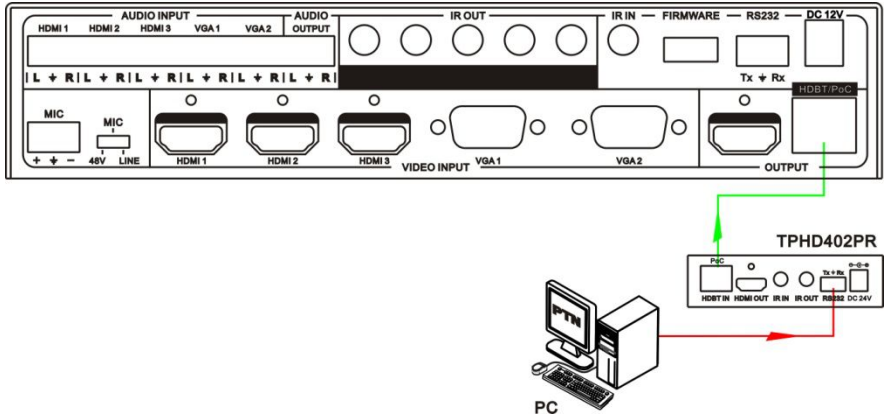

Control SC51T from remote

4.5 Operations in OSD Menu

SC51T provides a powerful OSD operation menu, contains 4 parts: optional settings, image settings, audio settings and system setting etc.

Press MENU button on front panel (or MENU button on IR remote/send command **50616%**) to enter in OSD menu, so it is able to do some settings through the OSD menu.

4.5.1 Option

Includes Output Adjust, Input4/5 Select, HDMI1/2/3 Audio select, and Software Update (USB)

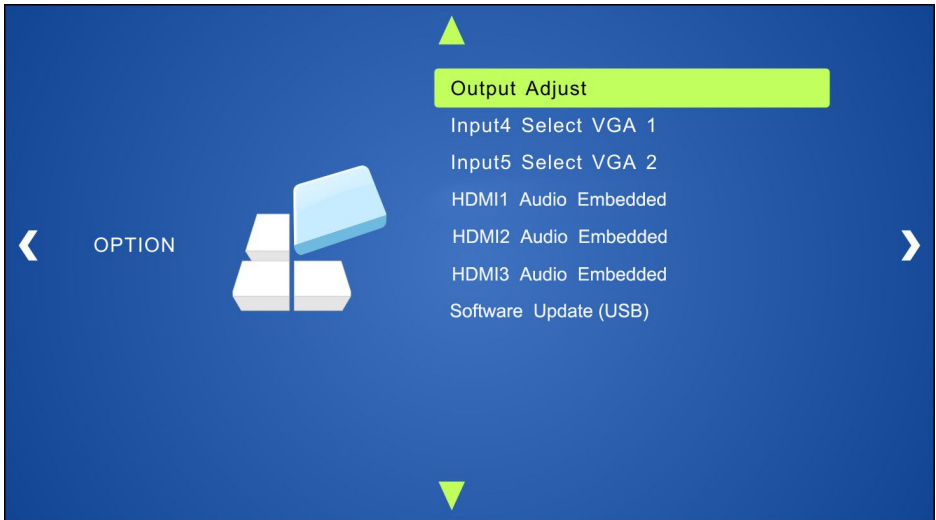

Output Adjust: Adjust output image position (X: horizontal direction and Y: vertical direction), **ratio aspect (width and height)**, **polarity adjustment (H Polarity and V Polarity)** and **output setting (HDMI on/off and HDBT on/off)**.

Input4 Select: Select video source format for VGA input, includes AV 1 (C-video signal), VGA 1 (VGA signal) and YPbPr 1 (Component video signal). **Press ENTER to switch among the options, and press Input 4 on the IR remote to confirm the selection.**

Input5 Select: Select video source for VGA input, includes AV 2 (C-video signal), VGA 2 (VGA signal) and YPbPr 2 (Component video signal). **Press ENTER to switch among the options, and press Input 5 on the IR remote to confirm the selection.**

For INPUT4 & INPUT5, when change for new format signal:

1. Firstly, please select a format through this menu (the signal format changed while the video source is still the same).
2. Secondly, switch off the present signal channel (e.g. switch to another channel).
3. Thirdly, switch to channel INPUT4/INPUT5 again.

HDMI1 Audio Select: switch between Embedded and Line to choose the desired audio output port for HDMI1.

HDMI2 Audio Select: switch between Embedded and Line to choose the desired audio output port for HDMI2.

HDMI3 Audio Select: switch between Embedded and Line to choose the desired audio output port for HDMI3.

Software Update (USB): Insert the USB flash disk with updating file to USB port of

Compact Scaler Switcher (with PoC)

SC51T, to update the software through this menu.

4.5.2 Picture

Including Picture Mode, Color Temperature, Aspect Ratio, Noise Reduction, Screen and Color Range.

Please check the picture below:

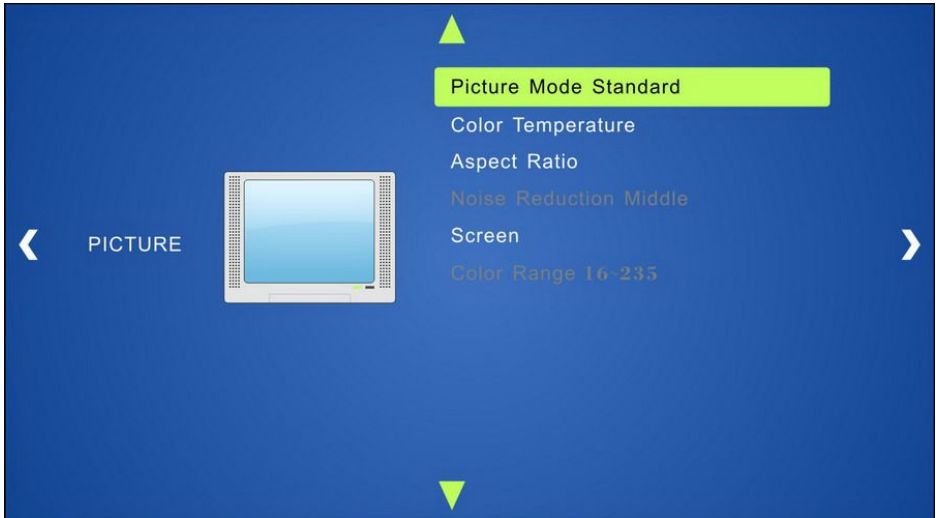

Picture mode: Includes Dynamic, Standard, Mild, and User. **Only in User mode, will it be able to set the image contrast, brightness, color and sharpness.**

Color Temperature: Includes Cool, Medium, Warm and User. And only in User mode, it is able to set values for Red, Green and Blue (RGB).

Aspect Ratio: Includes Native, 4:3, 16:9, Zoom1, Zoom2, Just Scan, and Panorama. VGA format only supports 4:3, 16:9 and Panorama.

Noise Reduction (not for VGA format): Includes Off, Low, Middle, High and Default.

Screen: (not for HDMI source): Includes Auto Adjust, Horizontal, Vertical, Size, and Phase.

Color Range (not for HDMI format): **16~235 or 0~255**, use ENTER button to select the desired color range.

4.5.3 Sound

Including Sound Mode, Surround Sound and EQ

Please check the picture below:

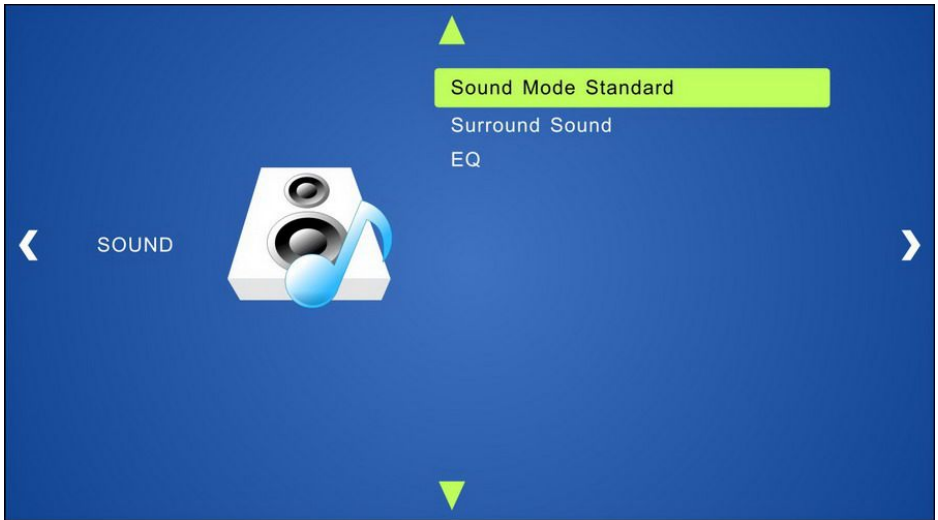

Sound mode: Includes Standard, Music, Movie, Sports and User. Only User mode supports to set treble and bass.

Surround Sound: Includes Off, Surround and SRS Trusurround XT.

EQ: To adjust the sound balance.

4.5.4 Setup

Including OSD Language, Restore Factory Default, Blending, HDMI CEC, OSD Duration and version inquiry

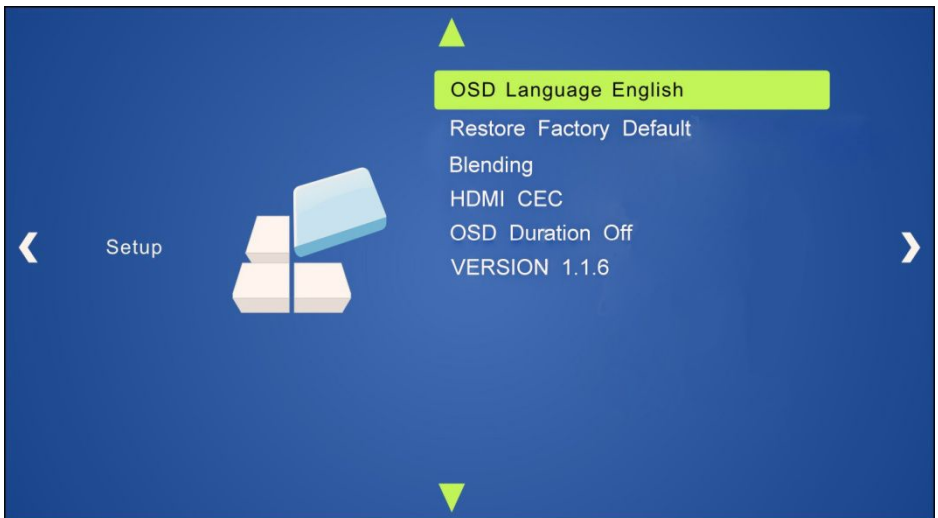

Compact Scaler Switcher (with PoC)

OSD Language: Supports 7 languages, including English (default), Chinese etc.

Restore Factory Default: Restores to original system state

Blending: Includes Low, Middle, High and Off. Use ENTER button to select.

HDMI CEC: Enable/disable CEC and auto-standby function. Default: CEC on, STANDBY on. **Only when CEC is on, will it be able to set auto-standby status.**

OSD Duration: Includes 5 s, 10 s, 15 s and Off. “s” is for Second.

VERSION: Displays software version

4.6 Instructions of VGA Converting Cable

As VGA source supports YPbPr and C-video source, SC51T provides with 2 VGA converting cables to compliant with these signals.

When need to select these signals as input source, please switch to channel INPUT 4 (or INPUT 5), and then set the signal type in OSD. And then switch to other input channel and connect INPUT 4 (or INPUT 5) with corresponding source device. At last, please switch to INPUT4 (or INPUT 5) again.

● Connect with Component Video (YPbPr) Source

A. Operation Examples:

1. Via front panel buttons & OSD

Press **MENU** button on front panel to enter in OSD, and then enter in **OPTION** setting menu: set “INPUT 4 Select” to **YPbPr1**, and “INPUT 5 Select” to **YPbPr2**. After setting, press **SOURCE/AUTO** button on front panel to switch to YPbPr1 or YPbPr2 source.

2. Via RS232 commands

Send command **50681%** (or **50684%**) to switch to YPbPr1 (or YPbPr2) source.

3. Via IR remote & OSD

Press **MENU** button on IR remote to enter in OSD, and then enter in **OPTION** setting menu: set “INPUT 4 Select” to **YPbPr1**, and “INPUT 5 Select” to **YPbPr2**. After setting, press **INPUT 4** (or **INPUT 5**) button to switch to YPbPr1 (or YPbPr2) source.

B. Connecting the VGA converting cable like this:

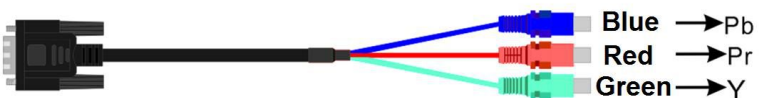

● **Connect with Composite Video (C-VIDEO) Source**

A. Operation Examples:

1. Via front panel buttons & OSD

Press **MENU** button on front panel to enter in OSD, and then enter in **OPTION** setting menu: set “INPUT 4 Select” to **AV1**, and “INPUT 5 Select” to **AV2**. After setting, press **SOURCE/AUTO** button on front panel to switch to AV1 or AV2 source.

2. Via RS232 commands

Send command **50682%** (or **50685%**) to switch to YPbPr1 (or YPbPr2) source.

3. Via IR remote & OSD

Press **MENU** button on IR remote to enter in OSD, and then enter in **OPTION** setting menu: set “INPUT 4 Select” to **AV1**, and “INPUT 5 Select” to **AV2**. After setting, press **INPUT 4** (or **INPUT 5**) button to switch to AV1 (or AV2) source.

B. Connecting the VGA converting cable like this:

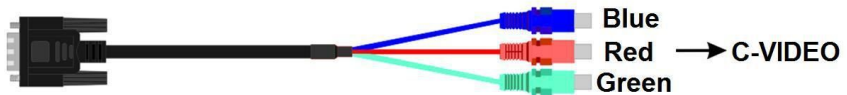

5. Specification

Video Input		Video Output	
Input	3 HDMI 2 VGA	Output	1 HDMI 1 HDBaseT
Input Connector	3 female HDMI 2 female VGA (15 pin)	Output Connector	1 female HDMI 1 RJ45
Video Signal	HDMI, YPbPr, C-video, VGA	Video Signal	1 HDMI 1 HDBaseT
IR Input		IR Output	
Input	1 IR IN	Output	5 IR OUT
Input Connector	3.5mm mini jack	Output Connector	3.5mm mini jack
Video General			
Resolution	1920x1200, 1920x1080, 1600x1200, 1360x768, 1280x800, 1280x720,	Bandwidth	HDMI:4.95Gbps(1.65Gbps per color) C-Video:150MHz YPbPr: 170MHz VGA: 375MHz

Compact Scaler Switcher (with PoC)

	1024x768		
Maximum Pixel Clock	165MHz	Video Impedance	75Ω
Gain	0dB	Input / Output Level	0.5V~2.0Vp-p
HDCP	Compliant with DVI & HDMI 1.3 standards		
Audio Input		Audio output	
Input	3 Dual-mono stereo audio for HDMI 2 Dual-mono stereo audio for VGA (Support C-VIDEO, YPbPr, VGA)	Output	1 stereo
Input Connector	3P captive (3.81mm)	Output Connector	3P captive (3.81mm)
Input Impedance	>10kΩ	Output Impedance	70Ω
Audio General			
Frequency Response	20Hz~20K Hz	Stereo Channel Separation	>80dB @1KHz
Control Parts			
Control/ Remote	IR remote, Buttons & RS232	Pin Configuration	2 = TX, 3 = RX, 5 = GND
General			
Temperature	-10 ~ +40°C	Humidity	10% ~ 90%
Power Supply	DC12V ± 0.5V	Power Consumption	8W , supply power to SC51T and TPHD402PR separately 16W , SC51T supplies power to TPHD402PR
Dimension (W*H*D)	220x 44x 148mm	Weight	0.65Kg

6. Panel Drawing

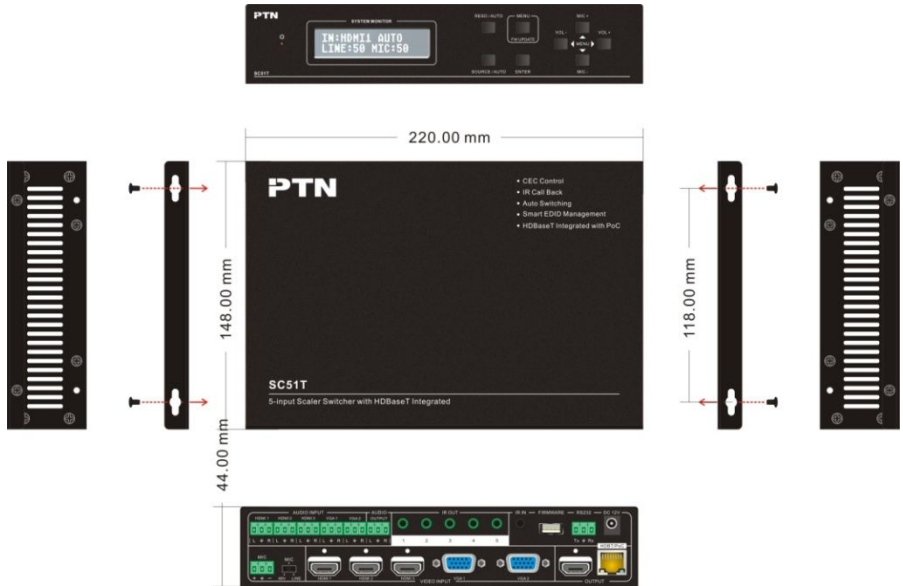

7. Troubleshooting & Maintenance

Problems	Causes	Solutions
Output image with snowflake	Bad quality of the connecting cable	Try another high quality cable.
	Fail or loose connection	Make sure the connection is good
No output image when switching	No signal at the input / output end	Check with oscilloscope or multimeter if there is any signal at the input/ output end.
	Fail or loose connection	Make sure the connection is good
	The switcher is broken	Send it to authorized dealer for repairing.

POWER indicator doesn't work or no respond to any operation	Fail connection of power cord.	Make sure the power cord connection is good.
EDID management does not work normally	The HDMI cable is broken at the output end.	Change for another HDMI cable which is in good working condition.
There is a blank screen on the display when switching	The display does not support the resolution of the video source.	Switch again.
		Manage the EDID data manually to make the resolution of the video source automatically compliant with the output resolution.
Static becomes stronger when connecting the video connectors	Bad grounding	Check the grounding and make sure it is connected well.
Cannot control the device by control device (e.g. a PC) through RS232 port	Wrong RS232 communication parameters	Type in correct RS232 communication parameters.
	Broken RS232 port	Send it to authorized dealer for checking.
Cannot control the device by front panel buttons while can control it through RS232 port	The front panel buttons are locked	Send command 50605% to unlock the front panel buttons.
Cannot control the device by RS232 / IR remote / front panel buttons	The device has already been broken.	Send it to authorized dealer for repairing.

If your problem persists after following the above troubleshooting steps, seek further help from authorized dealer or our technical support.

8. After-sales Service

If there appear some problems when running SC51T, please check and deal with the problems referring to this user manual. Any transport costs are borne by the users during the warranty.

1) Product Limited Warranty: PTN warrants that its products will be free from defects in materials and workmanship for **three years**, which starts from the first day you buy this product (The purchase invoice shall prevail).

Proof of purchase in the form of a bill of sale or receipted invoice which is evidence that the unit is within the Warranty period must be presented to obtain warranty service.

2) What the warranty does not cover:

- Warranty expiration.
- Factory applied serial number has been altered or removed from the product.
- Damage, deterioration or malfunction caused by:
 - Normal wear and tear
 - Use of supplies or parts not meeting our specifications
 - No certificate or invoice as the proof of warranty.
 - The product model showed on the warranty card does not match with the model of the product for repairing or had been altered.
 - Damage caused by force majeure.
 - Servicing not authorized by PTN
 - Any other causes which does not relate to a product defect
- Delivery, installation or labor charges for installation or setup of the product

3) Technical Support: Email to our after-sales department or make a call, please inform us the following information about your cases.

- Product version and name.
- Detailed failure situations.
- The formation of the cases.

Remarks: For any questions or problems, please try to get help from your local distributor, or email PTN at: support@PTN-electronics.com.



www.PTN-electronics.com

PTN Electronics Limited

Tel: +86-755-2846 1819

Fax: +86-755-8471 7796

Email: info@PTN-electronics.com

Website: www.PTN-electronics.com

