

# HDMI Matrix Switcher Series

ITEM NO.: HS10M 10 x 10 HDMI Matrix Switcher

**HS10M 10x10 HDMI Matrix Switch** allows you to route 10 HD sources to any 10 HD displays! The **10x10 HDMI Matrix switch** is a complete HD routing solution for whole home HDTV systems. It provides **3D support, UltraHD 4K2K**, and with **2U Rack** mountable for professional installations. In addition, the **HS10M** allows for effortless control of up to 10 devices through Ethernet control, Android/IOS App Control, IR remote control, RS-232 and the front panel.



## Features:

- Connect up to 10 HDMI source to 10 x HDMI display monitors.
- HDMI 1.4 with 3D, HDCP & DVI Compliant.
- High definition video up to 4K2K@24/25/30Hz@8bits, 1080p@60Hz@12bits.
- Audio supports up to LPCM 7.1 @ 192KHz · Dolby TrueHD · DTS-HD MA
- Easy to use front panel control of switching or using the included remote control.
- [Built in Ethernet Control and Android/iOS APP Control.](#)
- Built in RS232 console port to select input/output.
- Input/Output status could be displayed at front panel LCM & LED.

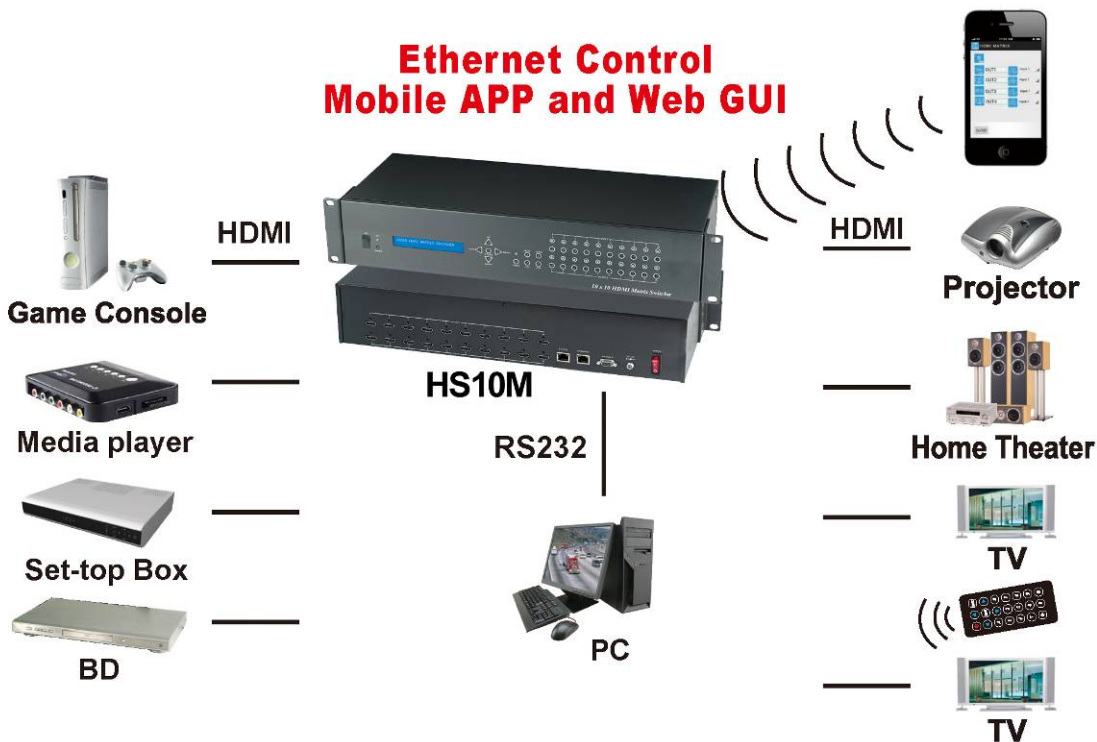

## 1.0 HS10M Panel View:

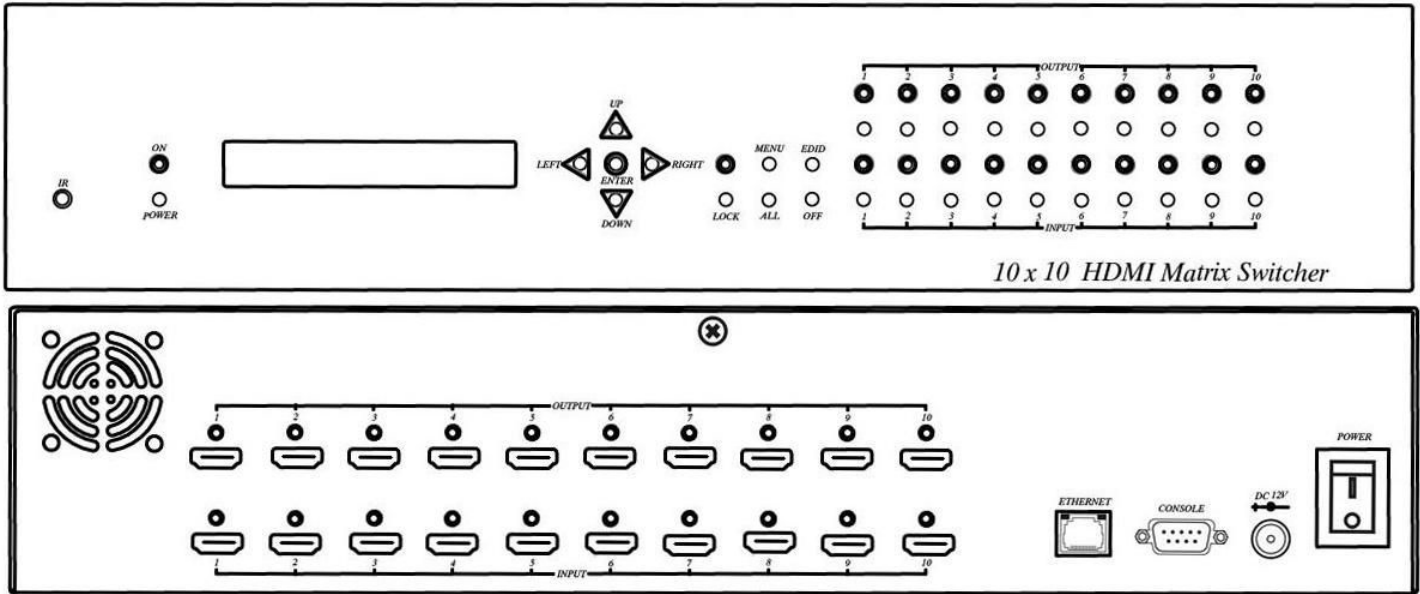

## 2.0 HS10M Connection View:

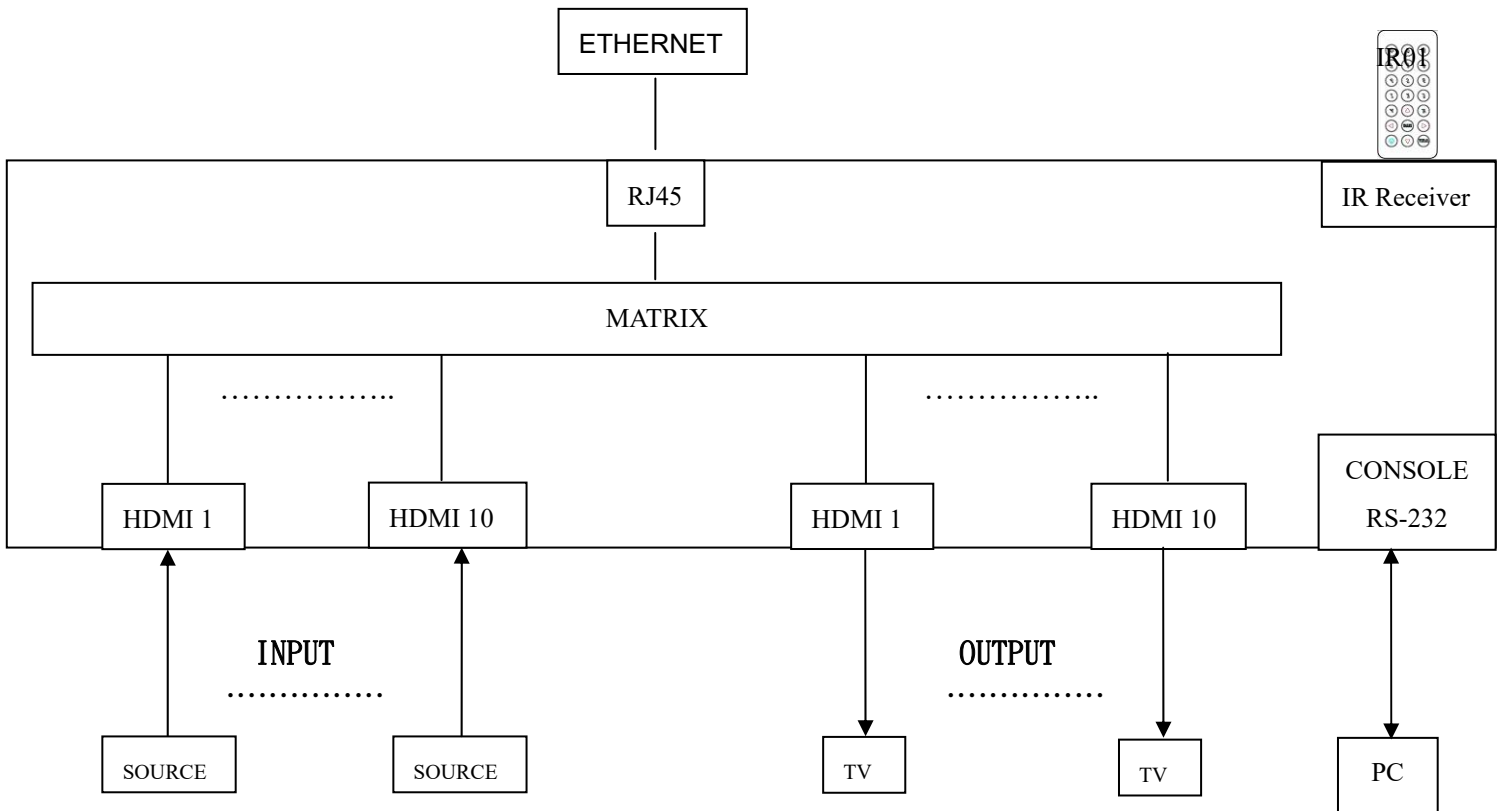

### 3.0 Keypad and LEDs

#### 3.1 Back Panel Switch and LED Indication:

POWER	Light on Light off	Power on Power off
RJ45	Yellow Green	Ethernet linked Ethernet data transmission

#### 3.2 Front Panel LED Indication:

ON	BLUE RED OFF	Power on Standby Power Off
INPUT 1~10	BLUE OFF	Signal indication No signal
OUTPUT 1~10	BLUE OFF	HDMI output indications Output unlink

**Standby mode: The IR Remote only could control POWER on/off.**

#### Front Button Function:

Power	Power on/standby
UP	Up
DOWN	Down
LEFT	Left
RIGHT	Right
ENTER	Select confirm key
MENU	Back to main menu/channel setting
EDID	Copy EDID
LOCK	Button lock
ALL	Set selected input channel to all output When press ALL the second line of panel will show IN and flashing, select the input 1~10 then press ENTER
OFF	Turn off selected output, could be 1~10 or ALL When press OFF the second line of panel will show IN and flashing, select the input 1~10 or ALL then press ENTER
OUTPUT 1~10	Fast switch output
INPUT 1~10	Fast switch input

### **3.3 Panel button Function:**

#### **OUTPUT 1~10 & INPUT 1~10**

Press OUTPUT 1~10 to select output port then the input at IN line of LCM will blink, press INPUT 1~10 to select input port to switch the channel

#### **ALL :**

Press ALL button, the IN line of LCM will blink, press INPUT 1~10 to select input port to all output port.

#### **OFF :**

Press OFF button, the IN line of LCM will blink, press ALL or OUTPUT 1~10 to select which port to turn off

#### **EDID :**

Press EDID button, it will show "From OUTPUT" at second line of LCM and the channel number will blink, press OUTPUT 1~10 to select which port to copy EDID.

#### **LOCK :**

Press LOCK till LOCK LED on then the panel button and IR remote control of MATRIX will be locked. Press LOCK till LOCK LED off to unlock.

\*When the sub-menu setting changed, press the ENTER key to complete the setting. If no press ENTER key, then the setting will be failed.

### 3.3 LCM Panel Function:

#### Power on Main Screen

When the power is on and the main screen appears

<b>10X10 HDMI MATRIX</b>
--------------------------

#### Channel Setting on Main Screen

The Matrix will jump to channel setting screen after 10 seconds, press the MENU key to enter the main menu

<b>OUT</b>	<b>1</b>	<b>2</b>	<b>3</b>	<b>4</b>	<b>5</b>	<b>6</b>	<b>7</b>	<b>8</b>	<b>9</b>	<b>10</b>
<b>IN</b>	<b>1</b>	<b>2</b>	<b>3</b>	<b>4</b>	<b>5</b>	<b>6</b>	<b>7</b>	<b>8</b>	<b>9</b>	<b>10</b>

#### Main MENU Option:

- \*1 - SWITCH
- 2 - SCENE
- 3 - ETHERNET
- 4 - EDID
- 5 - REMOTE ID
- 6 - VERSION

#### Operation:

- Press UP or DOWN key to move \* to select an item for setting and press ENTER key to enter into subpage.
- In MENU you could use key 1~6 of IR remote control to select the functions.
- When the selected sub-page setting is completed, press the MENU button to return to the main page

## 4.0 LCM Main MENU Function Operations:

### 4.1 SWITCH : (Default: 1 2 3 4 5 6 7 8 9 10)

This function is used to switch the input/output port. Enter the SWITCH menu. Press the ENTER key, then the LCM second line INPUT will flash. Press LEFT or RIGHT button to select the output to be modified. Then press Up or Down button to select the input port. After that, press ENTER to confirm setting.

It also works with INPUT/OUTPUT button of panel or IR remote

OUT	1	2	3	4	5	6	7	8	9	10
IN	1	2	3	4	5	6	7	8	9	10

---

### 4.2 SCENE:

SCENE function provide 10 sets of channel setting to fast reload for different application.

LOAD
SAVE

#### LOAD

Reload saved scene, press UP or DOWN to select the number of setting ENTER to load. At main screen you could use IR01 remote button **A** for quick load function, button **1~0** to select port number to load.

LOAD 1
1 2 3 4 5 6 7 8 9 10

#### SAVE

Save current channel setting, press UP or DOWN to select the number and ENTER to save. At main screen you could use IR01 remote button **B** for quick save function, button **1~0** to select port number to save.

SAVE 1
--------

## 4.3 Ethernet

- \* IP Address
- Subnet Mask
- Gateway
- DHCP Client
- Media Type
- MAC Filter

### IP Address: (Default: 192.168.0.10)

<b>IP Address</b> <b>192.168. 0.10</b>
---

This function can be setup MATRIX host intranet "IP Address", press the ENTER, the left-most number of second row will flash, then press the UP or DOWN button to change the numbers, , press LEFT or RIGHT to move to another location, the move to a position number will flash, press ENTER to complete the setting.

### Subnet Mask: (Default 255.255.255.0)

<b>Subnet Mask</b> <b>255.255.255.0</b>
--

This function can be setup MATRIX host intranet "Subnet Mask", press the ENTER, the left-most number of second row will flash, then press the UP or DOWN button to change the numbers Press the ENTER, , press LEFT or RIGHT to move to another location, the move to a position number will flash, press ENTER to complete the setting.

### Gateway: (Default 192.168.0.1)

<b>Gateway</b> <b>192.168. 0. 1</b>
--

This function can be setup MATRIX host intranet "Gateway", press the ENTER, the left-most number of second row will flash, then press the UP or DOWN button to change the numbers Press the ENTER, , press LEFT or RIGHT to move to another location, the move to a position number will flash, press ENTER to complete the setting.

### **DHCP Client: (Default Disable)**

**DHCP Client  
Disable**

When DHCP Clients setup at “Enable”, the MATRIX host will automatically get IP Address, Subnet Mask, Gateway, if setup at “Disable”, the MATRIX Host IP Address need go through “ ETHERNET” menu to set IP Address, Subnet Mask, Gateway, to press the ENTER, the second row will flash, then press the UP or DOWN to select DISABLE, ENABLE, then press ENTER to complete the setting.

### **Media Type: (Default AUTO)**

**Media Type  
AUTO**

This function can be setup MATRIX host intranet “Media Type, press the ENTER, the second row will flash, then press the UP or DOWN button to select AUTO 、 10MHalf 、 10MFull 、 100MHalf 、 100MFull, press ENTER to complete the setting.

### **MAC Filter : (Default Disable)**

**MAC FILTER  
DISABLE**

MAC Filter can be setup with registered MAC Address in order to connect the MATRIX host Web UI, MAC Address required by the Web page to fill in, this function can only be setup at “DISABLE”, “ENABLE”, then to press the ENTER, the second row will flash, then press the UP or DOWN to select DISABLE, ENABLE, then press ENTER to complete the setting.



#### 4.4 EDID: (Default: 1080P LPCM-2CH)

Because the player output display resolution will be based on TV EDID, this Matrix provides four default EDID modes: " BUILD-IN MODE", "COPY MODE", "I. EDID MODE" and "PC EDID MODE". For 4K2K resolution you have to copy the EDID from your 4K2K monitor.

- \* BUILD-IN MODE
- COPY MODE
- I. EDID MODE
- PC EDID MODE

##### 4.4.1 BUILD-IN MODE :

This mode supports video resolution 480p, 720p, 1080i / p at 24/50/60Hz, support 1080P LPCM two-channel audio and 5.1 channel. After enter BUILD-IN MODE menu, press UP or DOWN key to select 1080P LPCM-2CH or 1080P LPCM-5.1CH, then press ENTER to confirm setting.

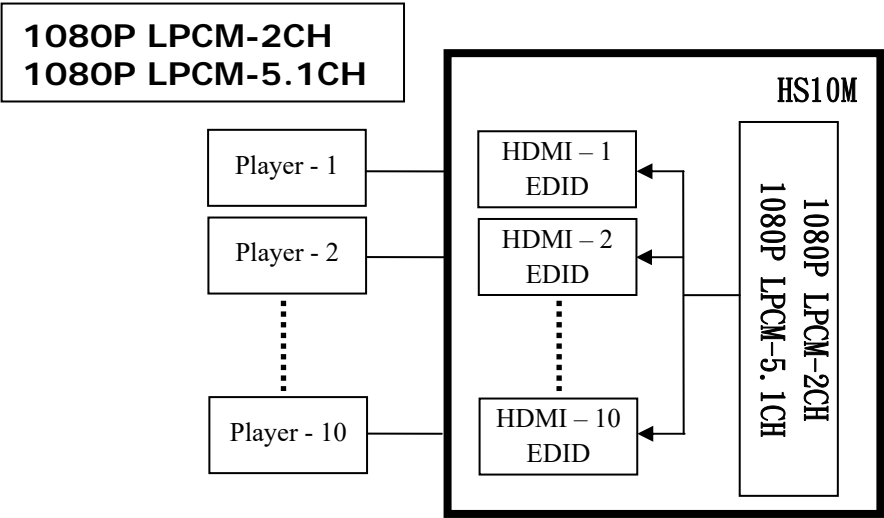

##### 4.4.2 COPY MODE :

To fully support the TV resolution and audio mode, the matrix provides "COPY MODE" to copy TV EDID for input source reference. When use the copy mode, recommend copying the lowest resolution TV EDID. Otherwise it may cause no picture display if the TV resolution is not able to support higher resolution.

After entering COPY MODE menu, press UP or DOWN button to select the OUTPUT (1 to 10) and press ENTER, then press UP or DOWN button to select the INPUT (1 to 10 or ALL) and press ENTER to confirm. **Only connected output will be shown in OUTPUT list.**

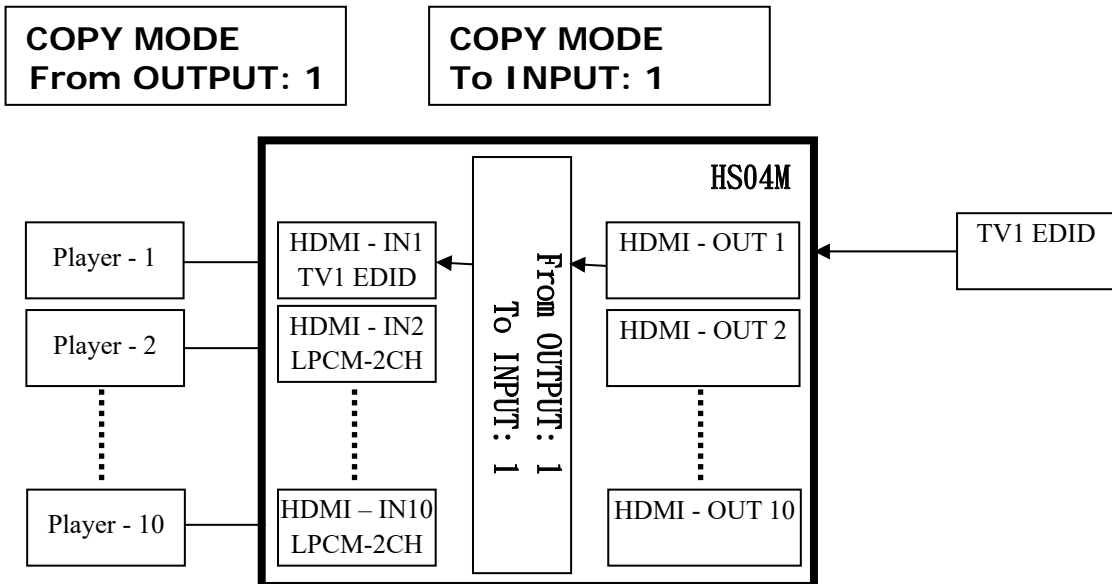

### 4.4.3 I. EDID MODE

In this mode MATRIX will integrate EDID from all HDMI OUTPUT to a greatest common factor resolution to all HDMI INPUT

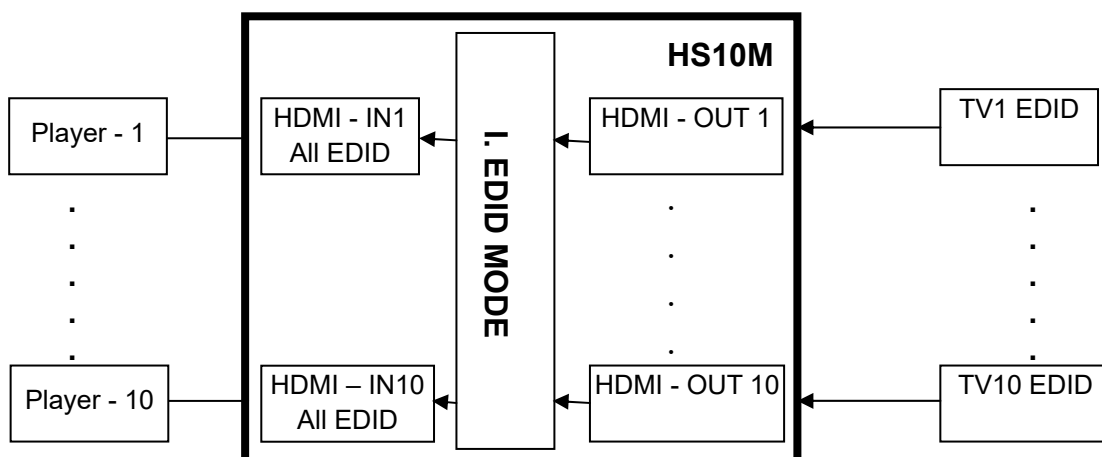

### 4.4.4 PC EDID MODE

In this mode you could upload EDID file from RS232 or RJ45 port of PC to MATRIX, please refer user manual of EDID Loader

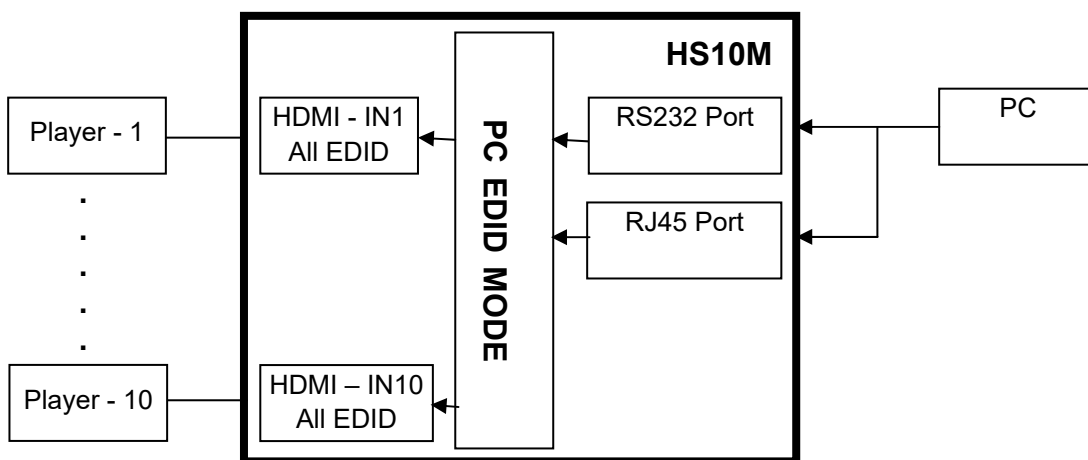

#### 4.5 REMOTE ID : (Default IR ID: 4)

This function must be set to match the Matrix remote control IR01 with the matrix itself. A conflict with other devices remote control is avoided.

After entering MATRIX IR ID menu, press ENTER, the LCM LINE 1 number will flash. Then Press UP or DOWN button to select the number, and then press ENTER to confirm.

When finish MATRIX IR ID setting, MATRIX remote control IR01 must also set the same ID in order to operation in normal.

Remote IR ID setting mode: Press and hold the POWER button, then press the number button which can be set from 0 to 9, total 10 groups. (See 5.1)

These settings on IR01 remote control have to be done the first time you use the IR01 or when you change the batteries.



#### 4.6 VERSION:

Display Matrix and WEB firmware version



## 5.0 Remote Control Function (IR01):



5.1 To command the matrix locally, setup the remote control IR01 ID with the same code of the Matrix (see 4.2). The default code is 4. (Power+4)

5.2 Warning: These settings have to be done the first time you use the IR01 or when you change the batteries.

- IR ID setup : press and hold POWER button , then press Number key

### Remote control button define:

#### Symbol



Power



LEFT



RIGHT



UP



DOWN



ENTER



MENU



#### Function

ON/Standby (same as Matrix)

Left (same as Matrix)

Right (same as Matrix)

Up (same as Matrix)

Down (same as Matrix)

Confirm (same as Matrix)

Menu (same as Matrix)

Quick key1

Quick key2

Quick key3

Quick key4

Quick key5



Quick key6



Quick key7



Quick key8



Quick key9



Quick key10



EDID (same as Matrix)



OFF (same as Matrix)

For example: to connect output port 1 to input port 4, press the quick key 1 (OUTPUT 1) and then press the quick key 4 (INPUT 4).

**\*IR remote can only power on the matrix at standby mode.**

## 6.0 REMOTE Control Function :

HS10M support RS232 and TCP/IP control by same command as below:

6.1

### For RS232 CONSOLE:

Connect the RS232 CONSOLE port to the COM port of the host by an F/M RS232 straight cable (pin 2 to pin 2; pin 3 to pin 3, pin 5 to pin 5)

Communication format is 9600, 8, N, 1 (9600 bps, 8 data bits, no parity check, 1 stop bit)

CONSOLE

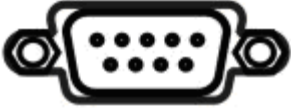

### For Ethernet TCP/IP(Winsock)

Default IP address: 192.168.0.10, Port:47011



## 6.2 Operation Instruction format:

Command +  $\Delta$ (Space) + Parameter + Enter

[Command]

[Description]

-----  
POWER $\Delta$ [y]

Power on/off

TX[n] $\Delta$ [n]

Set RXn to TXn

RX[n] $\Delta$ [m,m,m,m...]

Set RXn to multiple TXm,m,m,m...

MATRIX\_ID $\Delta$ [p]

Set Matrix IR ID

EDID\_COPY $\Delta$ [n]

Copy EDID from TX n

SAVE  $\Delta$ [n]

Save setting to #n

LOAD  $\Delta$ [n]

Load setting from #n

KEY $\Delta$ [y]

Panel button& IR remote control Lock/Unlock

DHCP $\Delta$ [y]

DHCP client on/off

IP\_ADDRESS $\Delta$ [x.x.x.x]

Set Matrix IP address

SUBNET\_MASK $\Delta$ [x.x.x.x]

Set Matrix subnet mask

GATEWAY $\Delta$ [x.x.x.x]

Set Matrix gateway

MEDIA\_TYPE $\Delta$ [z]

Network speed select

MAC_FILTER△[y]	Mac filter on/off
STATUS	Show connection status
VERSION	Show firmware version
HELP	Help

[Symbol]	[Parameter]
m	01~10, ff=ALL
n	00=off, 01~10=1~10
p	00~09=0~9
x	0~255
y	00=off, 01=on
z	00=auto, 01=10M, 02=100M

**Example:**

-To route input 4 to output 1, send the following string:

TX01△04Enter

-To route input 2 to all output, send the following string:

RX02△ffEnter

-To route input 2 to output 1,2,4, send the following string:

RX02△01,02,04Enter

-To put in standby the matrix, send the following string:

POWER△00Enter

Commands are **case insensitive**.

The Matrix will reply **OK** once string is correct, **NG** in case of incorrect string

## 7. Web Control Function:

### Initial IP Configuration

1. Setup MATRIX IP Address same as your PC with same domains.(Default 192.168.0.10)  
MATRIX IP Address method, please refer. to “ETHERNET” Chapter
2. Input IP Address on a web page, you could link to the Web UI of the MATRIX host.
3. Web UI Operation :

### SWITCH SETTING:

MATRIX

SWITCH SETTING

MATRIX-01

Power	Output	Input	
Power Off ▼	Output 1	Input 1 ▼ OFF Input 1 Input 2 Input 3 Input 4 Input 5 Input 6 Input 7 Input 8 Input 9 Input 10 input 10	Reload Advanced
	Output 2		
	Output 3		
	Output 4		Apply
	Output 5		
	Output 6		
	Output 7	Input 7 ▼	
	Output 8	Input 8 ▼	
	Output 9	Input 9 ▼	
	Output 10	Input 10 ▼	
	All port	NA ▼	

Version V1.24

- **Power** : Control MATRIX power on and standby.
- **Output** : Display output 1~10, it can change the display name by the Aliases page.
- **Input** : Display input 1~10, this field is a drop down menu, this field is a drop-down menu, a drop-down menu include Input 1 ~ 10 and OFF, It can change the display name by the Aliases page.
- **Reload** : Get MATRIX host message.
- **Advanced** : Enter into the “Advanced” page.
- **Apply** : Complete the setting
- **All Port** : Set all output from input 1~10 or off at once.



## Advanced:

**MATRIX**

Advanced

<b>IP address</b>	192.168.0.10
<b>Subnet mask</b>	255.255.255.0
<b>Gateway IP</b>	192.168.0.1
<b>Media Type</b>	Auto detect ▼
<b>DHCP Client</b>	Disable ▼
<b>Auto Reset</b> (No data input)	2 (1 ~ 255 Minute)
<b>Device Name</b>	MATRIX-01

MAC address  OnLine

MemoryMAC FilterAliasesBackApply

- **IP address** : Change **IP address**
- **Subnet mask** : Change **Subnet mask**
- **Gateway IP** : Change **Gateway IP**
- **Media Type** : Change **10 / 100 / Auto detect**
- **DHCP Client** : When setup at **Enable**, the MATRIX host will automatic get **IP Address** 、**Subnet Mask** 、**Gateway**, If setup at **Disable**, the **MATRIX** host **IP Address** 、**Subnet Mask** 、**Gateway** need to set from Advanced page.
- **Auto Reset** : The terminal connection people will be 4 users on line at same time, this function could setup the linking time to avoid long time linking and other user can not used. When over the setting link time, the terminal will automatically disconnect the link. . (0: no time setup, 1 ~ 255 Minute time range that can be setup)
- **Memory** : Click to enter **Memory** setup page
- **MAC Filter** : Click to enter **MAC Filter** setup page
- **Aliases** : Click to enter **Aliases** setup page
- **Device Name** : Can change device name
- **Back** : Back to **SWITCH SETTING** page
- **Online** : Terminal connection users display, the max. 4 users on line.

## Aliases:

Output		Input	
Output 1	Output 1	Input 1	Input 1
Output 2	Output 2	Input 2	Input 2
Output 3	Output 3	Input 3	Input 3
Output 4	Output 4	Input 4	Input 4
Output 5	Output 5	Input 5	Input 5
Output 6	Output 6	Input 6	Input 6
Output 7	Output 7	Input 7	Input 7
Output 8	Output 8	Input 8	Input 8
Output 9	Output 9	Input 9	Input 9
Output 10	Output 10	Input 10	Input 10

Back Apply

- **Aliases** page can change input/output name, enter **Apply** to finish the setting after change  
The new name will update and correspond to **SWITCH SETTING** page Output / Input.
- Press **Back** jump back to **advanced** page.

## MAC Filter:

MAC Filter	Enable
MAC address 1	11-22-33-44-55-66
MAC address 2	00-00-00-00-00-00
MAC address 3	00-00-00-00-00-00
MAC address 4	00-00-00-00-00-00
MAC address 5	00-00-00-00-00-00
MAC address 6	00-00-00-00-00-00
MAC address 7	00-00-00-00-00-00
MAC address 8	00-00-00-00-00-00
MAC address 9	00-00-00-00-00-00
MAC address 10	00-00-00-00-00-00

Back Apply

- **MAC Filter** can be setup as registered **MAC Address** to link **MATRIX** host **Web UI** , the max. up to 10 groups **MAC Address**
- After **MAC Address** fill in, select **Enable** and press **Apply** to complete the setting.
- Press **Back** jump to **advanced** page.

## MEMORY:

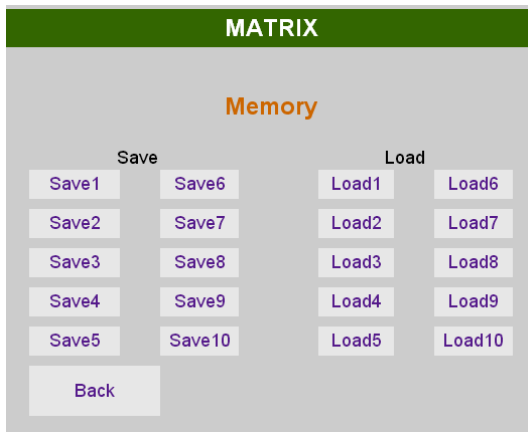

- **Save** : Save 10 set of channel settings
- **Load** : Reload 1 of the channel settings
- **Back** : Back to **Advanced** page

## 8. Android APP Function:

APP name: Matrix Controller



### System Requirement

Android 4.0 and up

Size: 1.2M

Language: English, Traditional Chinese, Simplified Chinese

### Google Play Download Link

<https://play.google.com/store/apps/details?id=sct.com.matrixcontroller>

### Google Play Download QR code



### System Setting

Connect mobile phone to Wi-Fi and set the IP/ subnet mask same with matrix network segment

Default IP address of 10 by 10 matrix is 192.168.0.10

Default IP address of 4 by 4 matrix is 192.168.0.200

Default subnet mask is 255.255.255.0

You could also set to DHCP mode, please refer user manual

There are two ways to get the IP address of matrix:

1. Use APP function: Scan Device to get the IP address.
2. Use panel button or IR remote control by press [MENU], select to [ETHERNET] function and press [ENTER] to enter [IP Address] function than press [ENTER], it will show IP Address in the LCD panel of matrix

## Main Page:

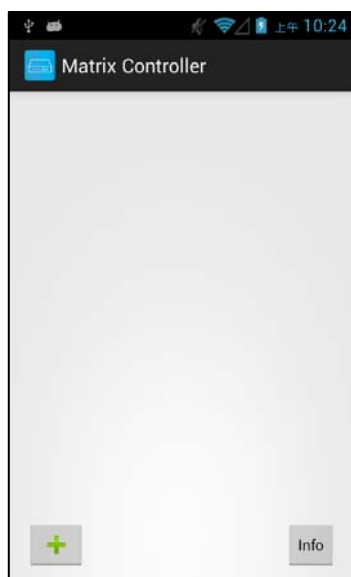

When first time enter the APP will see the main page

Bottom left 「+」 to add matrix

Bottom right 「Info」 to show information

## Scan Device

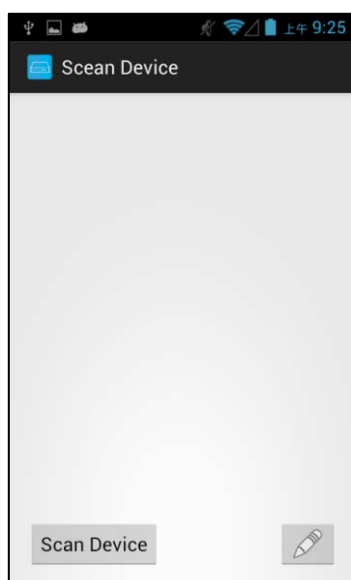

Touch 「+」 button at main screen to enter 「Scan Device」 page

Touch bottom left 「Scan Device」 to start scan

Touch bottom right pen icon to input the IP address manually

## Add Matrix



After scanning it will show all matrixes in the list

Touch the IP in list to enter 「Add Device」 page

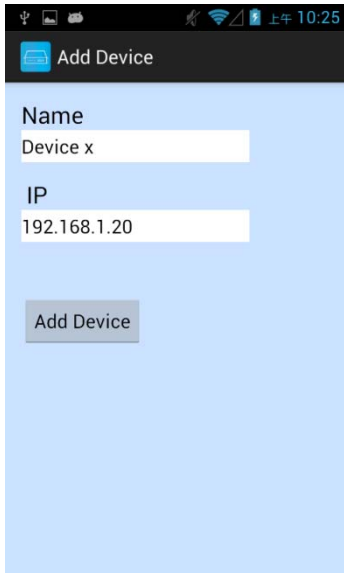

Enter the name of matrix then touch 「 Add Device 」 to finish setting  
**Notice : Name should be unique, not allow duplicate**

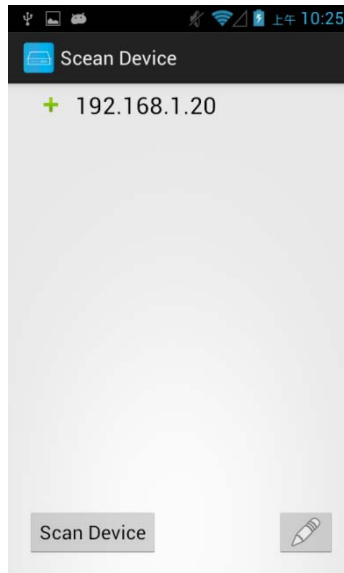

It will show 「 + 」 icon in front of the IP address when finished



Return to main screen you will see the matrix which just add

# Modify Device



Press the matrix name to show pop-up dialog

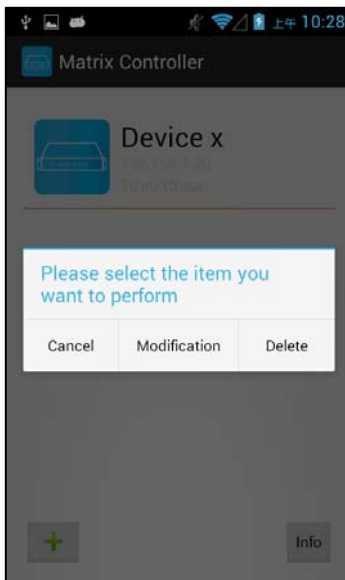

Touch 「Modification」 to enter modification page.

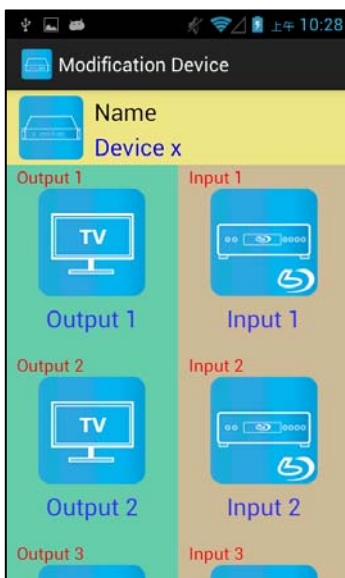

Yellow block shows matrix name and icon

Green block shows name and icon of output devices

Brown block shows name and icon of input devices

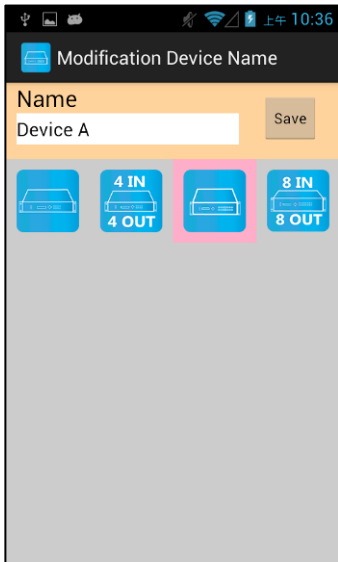

Touch yellow block to modify matrix name and icon

Input the name and select the icon you prefer then touch 「 Save 」 to finish

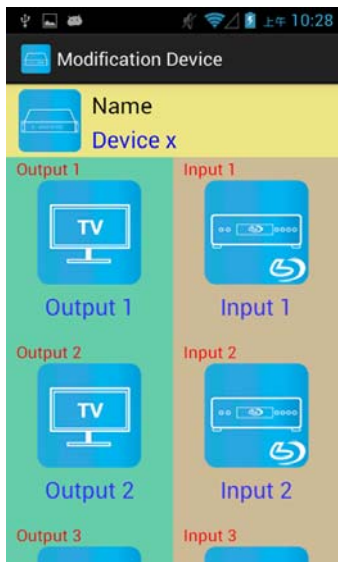

Return to Modification page you will see the matrix have been changed

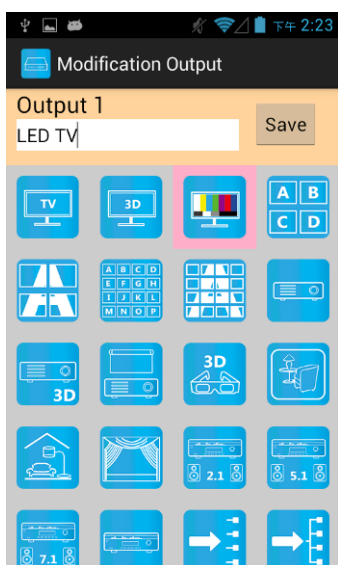

Touch green block to modify output name and icon

Input the name and select the icon you prefer then touch 「 Save 」 to finish



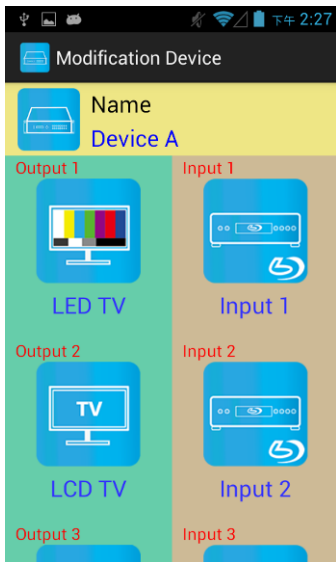

Return to Modification page you will see the output have been changed

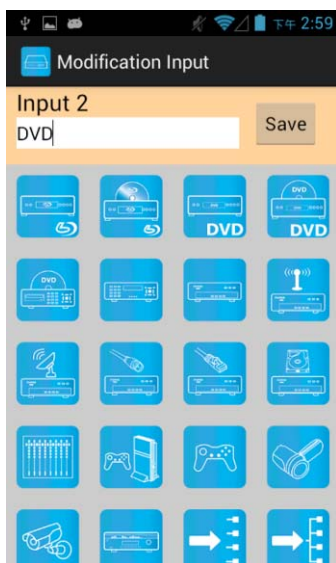

Touch brown block to modify input name and icon

Input the name and select the icon you prefer then touch 「 Save 」 to finish

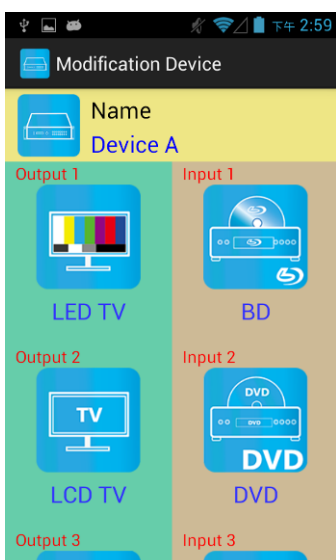

Return to Modification page you will see the input have been changed

## Channel Switching mode (load scene, input selection, output selection)

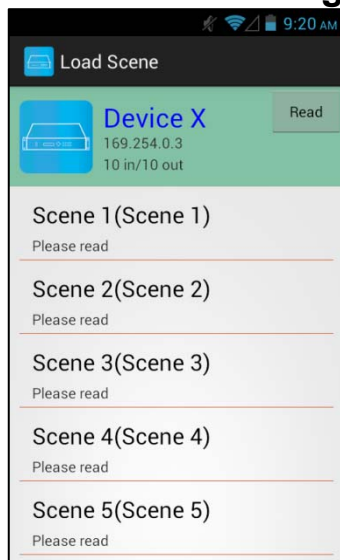

Click device name in list to enter load scene page



Slide right from load scene page to enter input selection mode (as before)



Slide left from load scene page to enter output selection mode (support multiple selection)

## Load scene

### Modify scene name

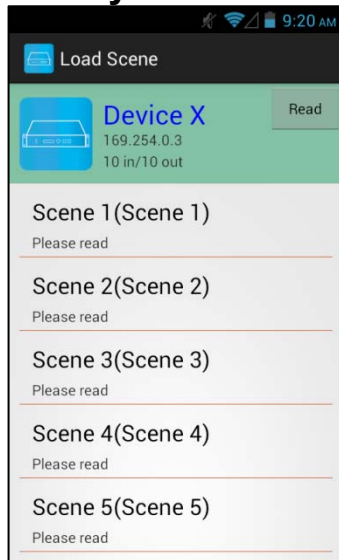

Press scene column to show pop-up dialog to modify scene name

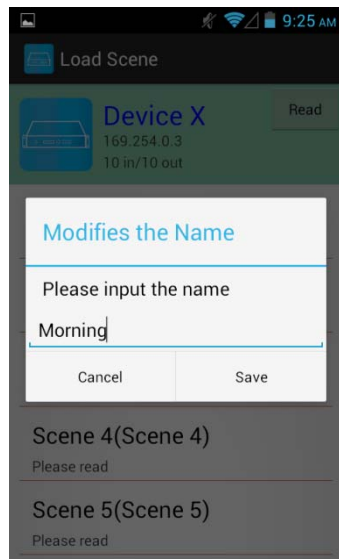

After modification touch 「 Save 」 to save scene name  
It will return to Load Scene page automatically.

**Notice : Name should be unique, not allow duplicate or empty**

## Read scene status

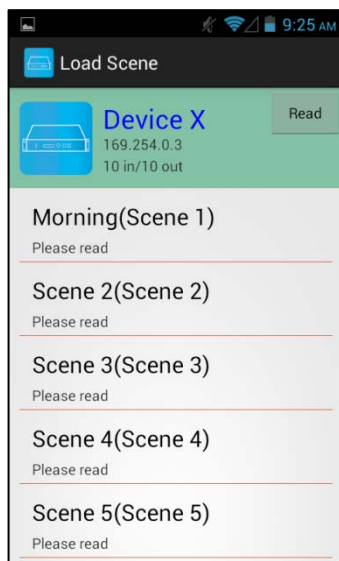

Touch top right 「 Read 」 to renew the scene status

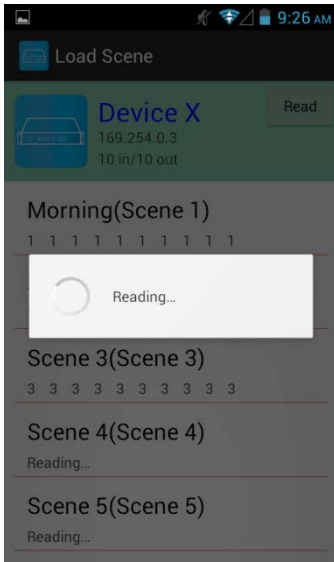

It will show pop-up message 「Reading...」  
 After reading it will refresh scene status

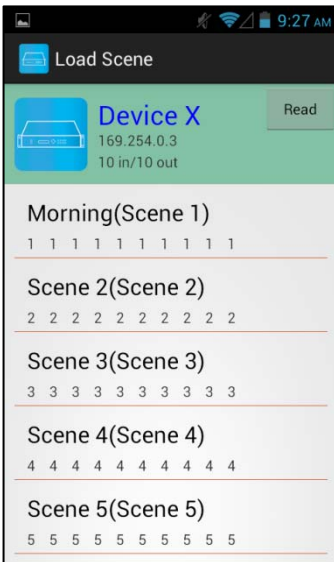

Touch the column name to show pop-up dialog

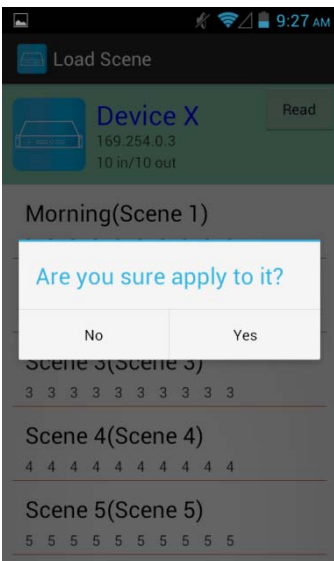

Touch 「Yes」 to apply scene

# Input Selection Mode



Top right 「 Refresh 」 to renew the status of matrix  
 Below 「 Refresh 」 button to power on/off the matrix  
 The block under device are Output 1~ Output 10  
 (4 by 4 matrix only shows Output 1~Output 4)  
 Left side shows output device name  
 Right side shows current input device name

Bottom left 「 Save Scene 」 to save the scenes



Touch output block to enter Channel Selection page

Touch input device to switch or ON/OFF icon to power on/off



It will return to Input Selection page after switching and you will see the input have been changed

## Output Selection Mode

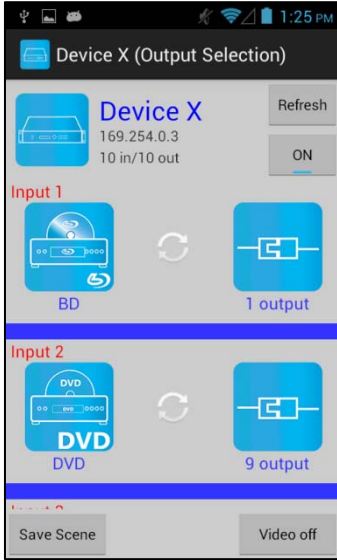

Top right 「Refresh」 to renew the status of matrix

Below 「Refresh」 button to power on/off the matrix

The blocks under device are Input 1~ Input 10

(4 by 4 matrix only shows Input 1~Input 4)

Left side shows input device name

Right side shows current output numbers of devices

Bottom left 「Save Scene」 to save the scenes

Bottom right 「Video off」 to turn off video output

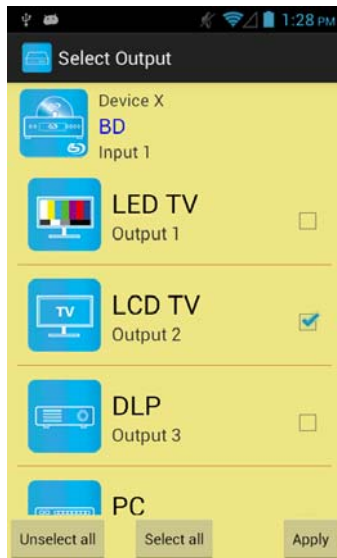

Touch input block or 「Video off」 to enter Output Selection page

It will show connected output of current input

Bottom left 「Unselect all」 to clear all output box

Bottom center 「Select all」 to check all output box

Bottom right 「Apply」 to apply output setting

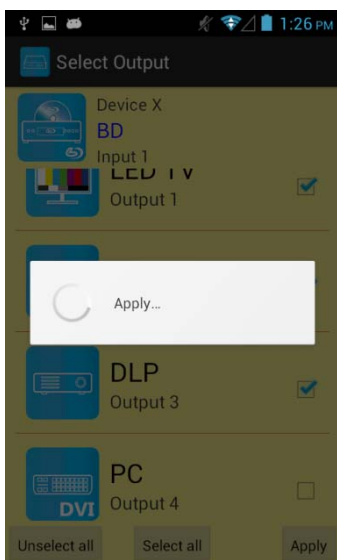

After touch 「Apply」 it will show pop-up message 「Apply...」

It will return to Input Selection page after switching and you will see the numbers of output have been changed

## Save Scene



In Input or Output Selection page touch bottom left 「 Save Scene 」 to enter Save Scene page

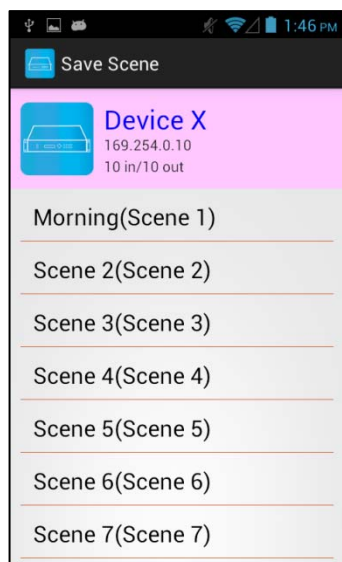

Touch the Scene column to show pop-up dialog

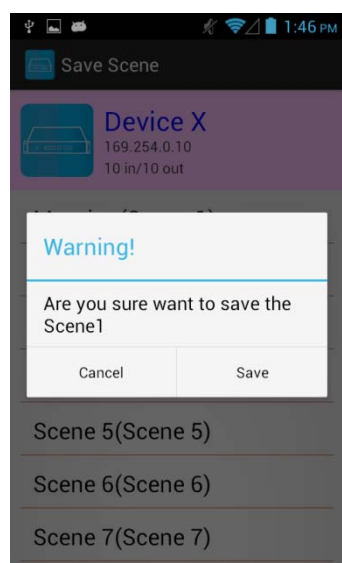

Touch 「 Save 」 to save current channels setting for all output  
It will return to Save Scene page automatically.

## Delete Matrix

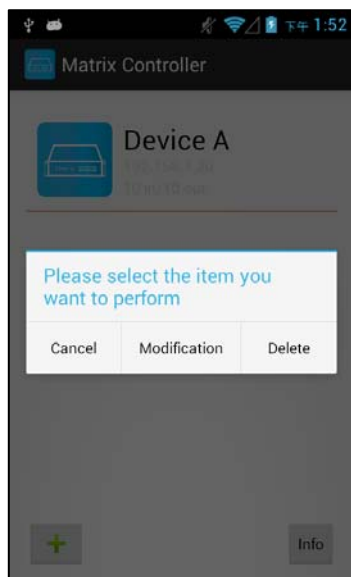

Press the block of matrix in Controller page to show pop-up dialog then touch 「Delete」

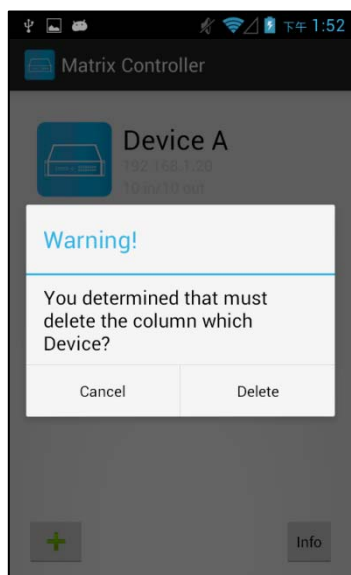

Touch 「Delete」 to delete the matrix



## 9. iOS APP Function:

APP name: Matrix Controller



### System Requirement

iOS 7.1 and up

Size: 2.3M

Language: English, Traditional Chinese, Simplified Chinese

### iTunes Download Link

<https://itunes.apple.com/us/app/matrix-control/id904487754?l=zh&ls=1&mt=8>

### iTunes Download QR code



### System Setting

Connect mobile phone to Wi-Fi and set the IP/ subnet mask same with matrix network segment

Default IP address of 10 by 10 matrix is 192.168.0.10

Default IP address of 4 by 4 matrix is 192.168.0.200

Default subnet mask is 255.255.255.0

You could also set to DHCP mode, please refer user manual

There are two ways to get the IP address of matrix:

1. Use APP function: Scan Device to get the IP address.
2. Use panel button or IR remote control by press [MENU], select to [ETHERNET] function and press [ENTER] to enter [IP Address] function than press [ENTER], it will show IP Address in the LCD panel of matrix

## Main Page:



When first time enter the APP will see the main page

Bottom left 「+」 to add matrix

Bottom right 「Info」 to show information

## Scan Device



Touch 「+」 button at main screen to enter 「Scan Device」 page

Touch bottom left 「Scan Device」 to start scan

Touch bottom right pen icon to input the IP address manually

## Add Matrix

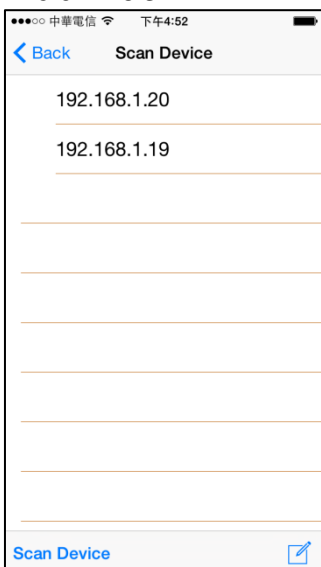

After scanning it will show all matrixes in the list

Touch the IP in list to enter 「Add Device」 page

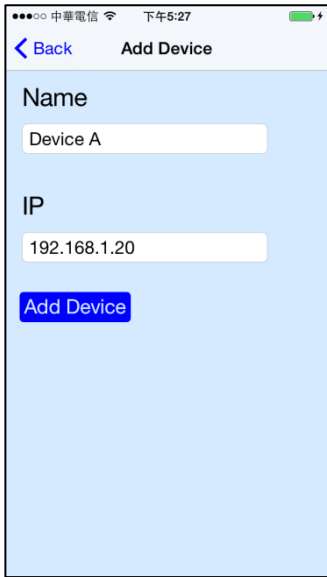

Enter the name of matrix then touch 「Add Device」 to finish setting  
**Notice : Name should be unique, not allow duplicate**

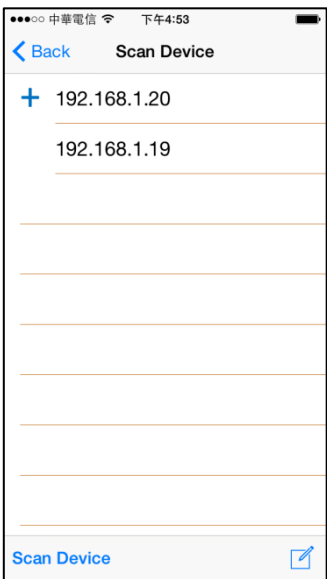

It will show 「+」 icon in front of the IP address when finished

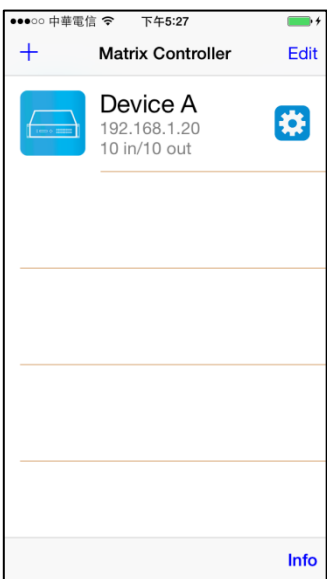

Return to main screen you will see the matrix which just add

# Modify Device

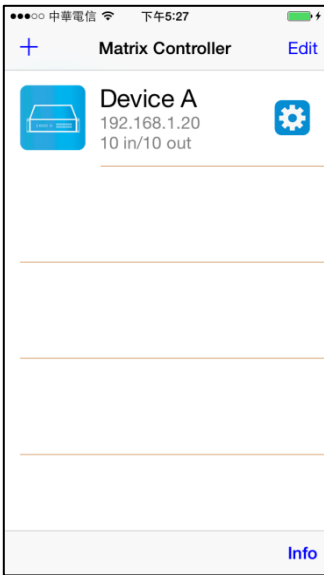

Touch the gear icon to enter Modification page

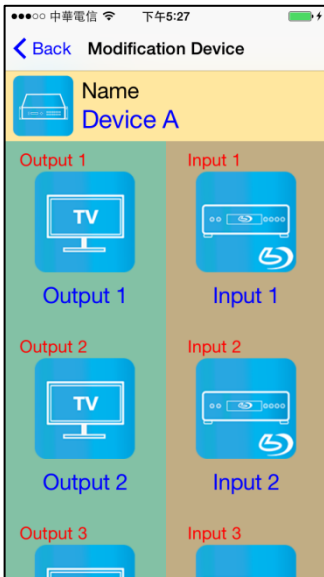

Yellow block shows matrix name and icon

Green block shows name and icon of output devices  
Brown block shows name and icon of input devices

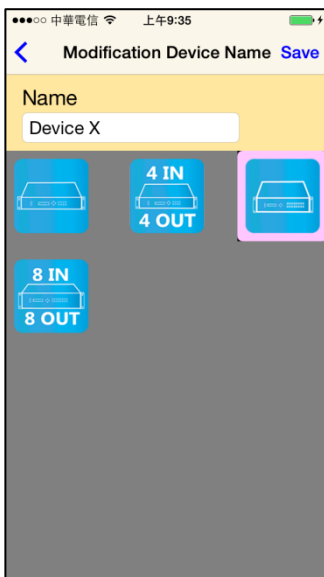

Touch yellow block to modify matrix name and icon  
Input the name and select the icon you prefer then touch 「Save」 to finish

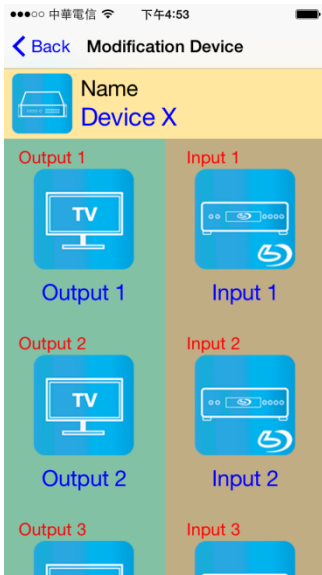

Return to Modification page you will see the matrix have been changed

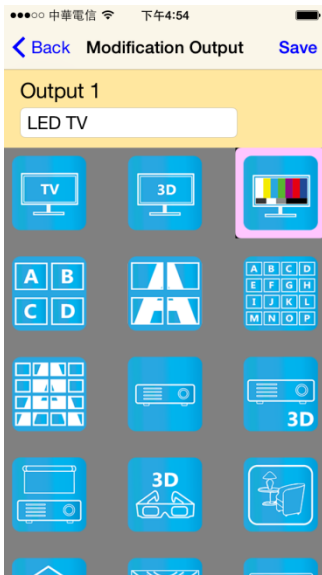

Touch green block to modify output name and icon  
Input the name and select the icon you prefer then touch 「 Save 」 to finish

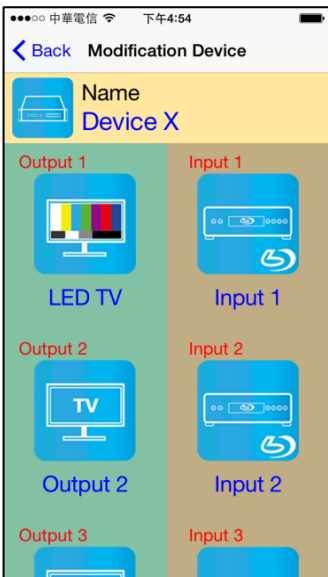

Return to Modification page you will see the output have been changed

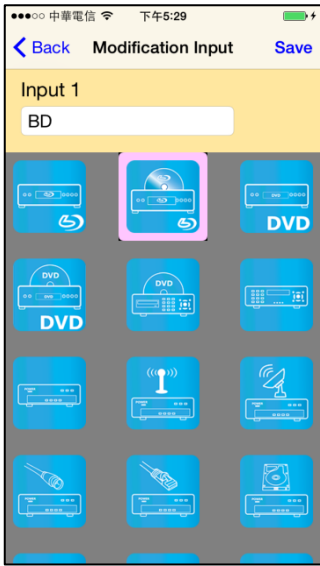

Touch brown block to modify input name and icon  
Input the name and select the icon you prefer then touch 「 Save 」 to finish

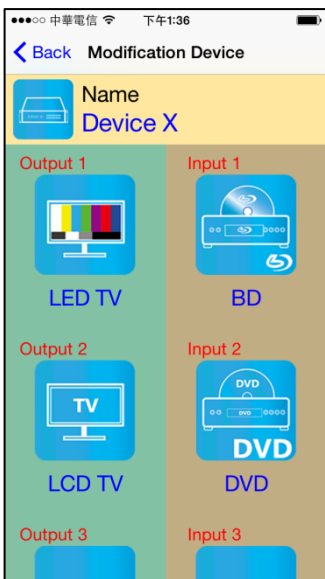

Return to Modification page you will see the input have been changed

## Channel Switching mode (load scene, input selection, output selection)

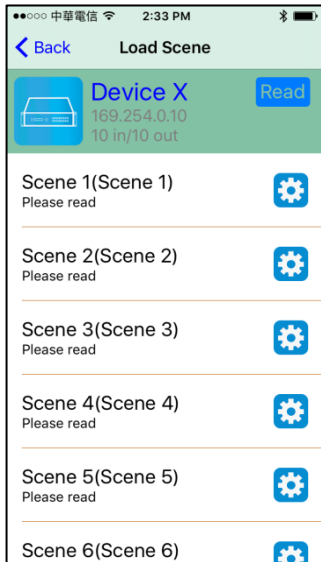

Click device name in list to enter load scene page

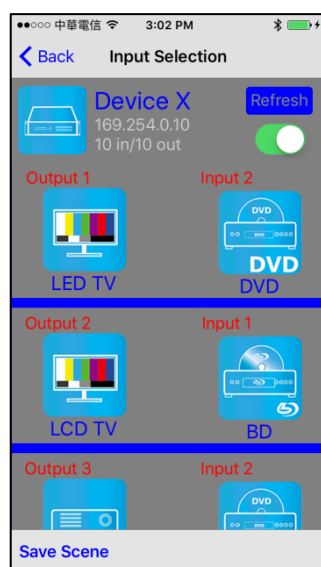

Slide right from load scene page to enter input selection mode (as before)

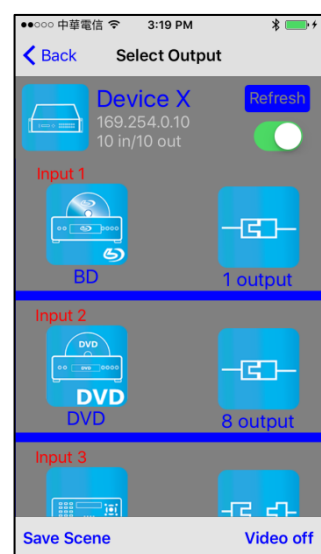

Slide left from load scene page to enter output selection mode (support multiple selection)

## Load scene

### Modify scene name

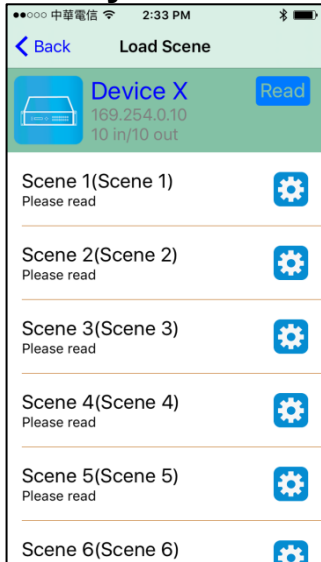

Touch the gear icon to enter modify scene name



After modification touch 「 Save 」 to save scene name  
It will return to Load Scene page automatically.

**Notice : Name should be unique, not allow duplicate or empty**

## Read scene status

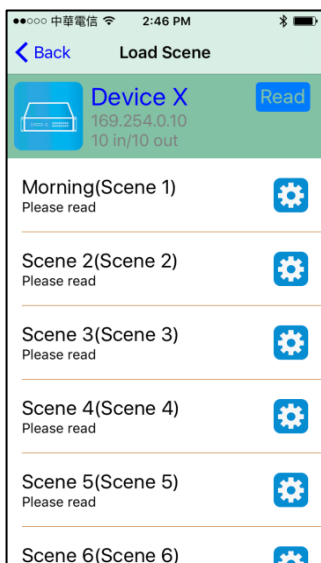

Touch top right 「 Read 」 to renew the scene status



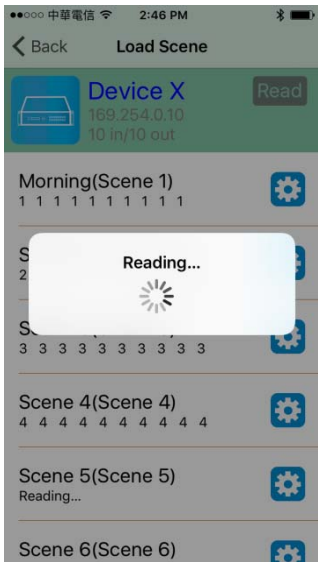

It will show pop-up message 「Reading...」  
 After reading it will refresh scene status

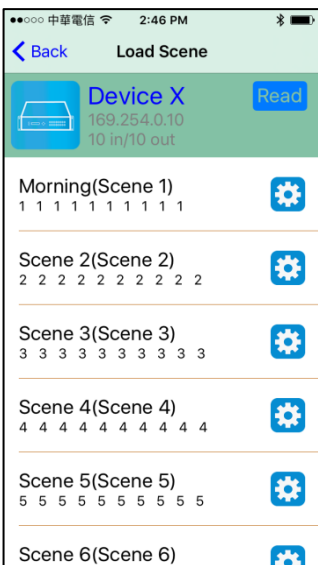

Touch the column name to show pop-up dialog

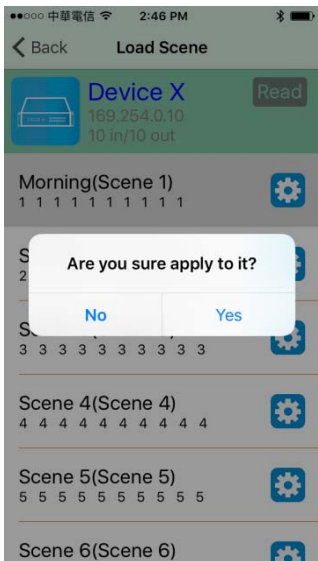

Touch 「Yes」 to apply scene

# Input Selection Mode

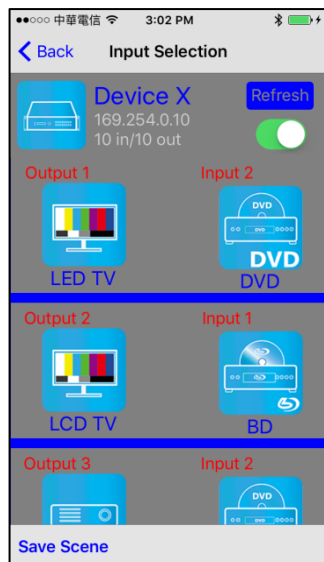

Top right 「 Refresh 」 to renew the status of matrix  
 Below 「 Refresh 」 button to power on/off the matrix

The block under device are Output 1~ Output 10  
 (4 by 4 matrix only shows Output 1~Output 4)  
 Left side shows output device name  
 Right side shows current input device name

Bottom left 「 Save Scene 」 to save the scenes



Touch output block to enter Channel Selection page

Touch input device to switch or ON/OFF icon to power on/off

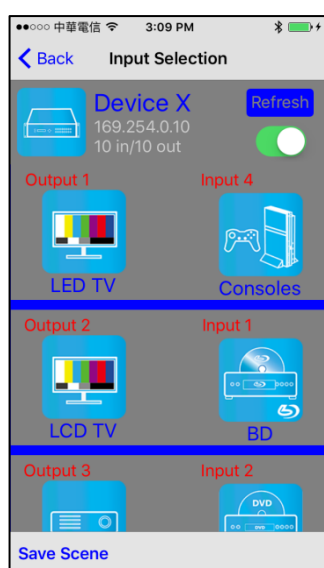

It will return to Input Selection page after switching and you will see the input have been changed

# Output Selection Mode

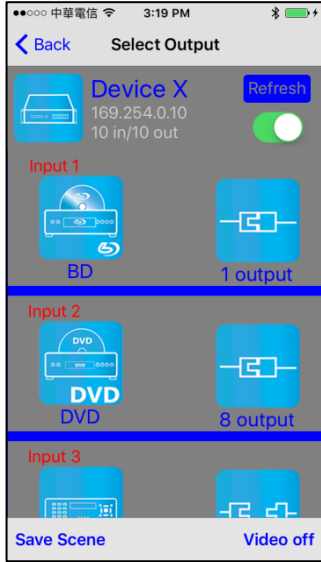

Top right 「Refresh」 to renew the status of matrix  
 Below 「Refresh」 button to power on/off the matrix

The blocks under device are Input 1~ Input 10  
 (4 by 4 matrix only shows Input 1~Input 4)  
 Left side shows input device name  
 Right side shows current output numbers of devices

Bottom left 「Save Scene」 to save the scenes  
 Bottom right 「Video off」 to turn off video output

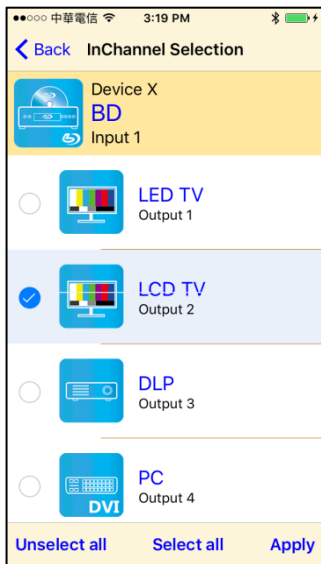

Touch input block or 「Video off」 to enter Output Selection page  
 It will show connected output of current input

Bottom left 「Unselect all」 to clear all output box  
 Bottom center 「Select all」 to check all output box  
 Bottom right 「Apply」 to apply output setting



After touch 「Apply」 it will show pop-up message 「Apply...」

It will return to Input Selection page after switching and you will see the numbers of output have been changed

# Save Scene

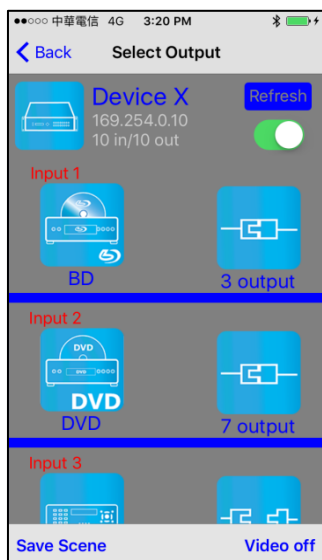

In Input or Output Selection page touch bottom left 「 Save Scene 」 to enter Save Scene page

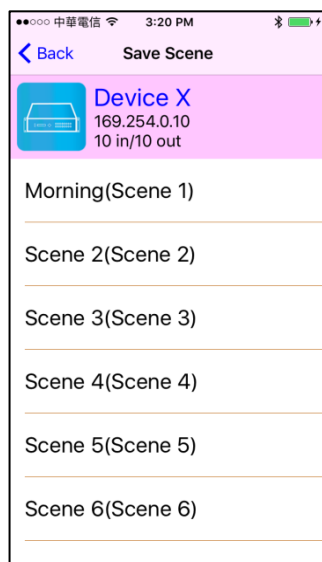

Touch the Scene column to show pop-up dialog

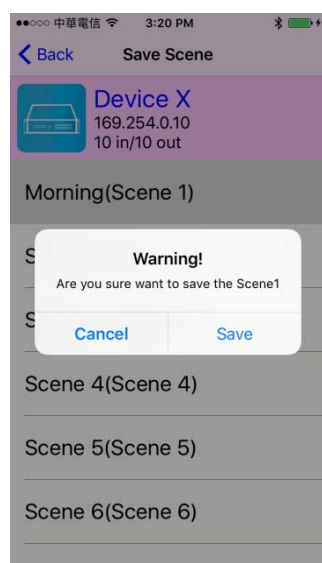

Touch 「 Save 」 to save current channels setting for all output  
It will return to Save Scene page automatically.

## Delete Matrix

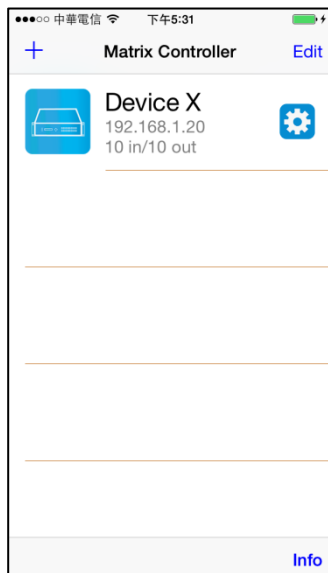

Touch top right 「Edit」 button to enter delete mode

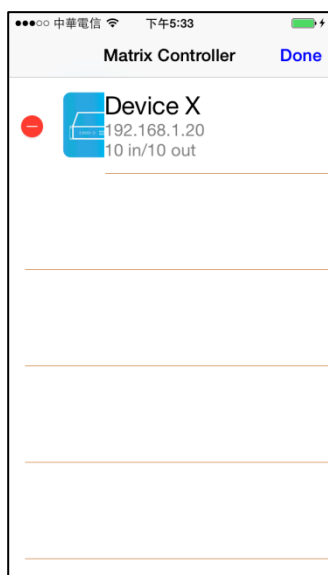

Touch 「-」 button in the left of matrix

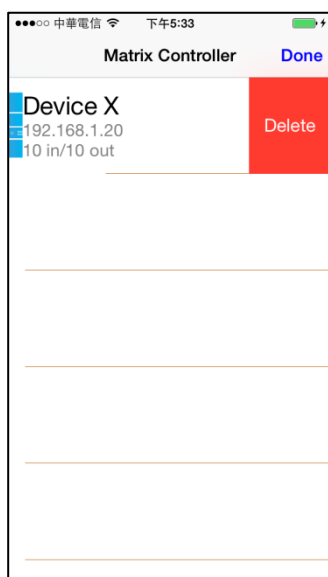

Touch 「Delete」 to delete the matrix

Touch top right 「Done」 to exit

## Specification:

ITEM NO	HS10M
HDMI Resolution	4096x2160p@24/25/30Hz 8bit RGB444, 1080p@60Hz 12bit, 3D
Video Input Interface	HDMI Type A x 10
Video Output Interface	HDMI Type A x 10
RS-232 Input/Output Interface	DB9 x 1(CONSOLE)
IR Receive Angle	± 45 degree
IR Receive Distance	5M
Power Adapter	DC 12V 6.7A
Power Consumption	5A
Temperature	Operation: 0 to 55°C, Storage: -20 to 85°C, Humidity: up to 95%
Dimension mm	483 x 197 x 88
Weight g	3900



Rev.A V1.24